

INVERTER

INVERTER USER'S MANUAL

ZVFG7 SERIES

ZVFP7 SERIES



Foreword

- Thank you very much for your purchase of ZVFG7 and ZVFP7 series of inverters.
 - This manual introduces the installation, operation, function setting, trouble shooting and etc. of inverters.
 - Incorrect installation or use may result in damage or other accidents. Do read all instructions in detail before installing or operating.
 - Ensure that this manual is made available to the final user and keep it handy for future reference.
 - If there is any doubt or question, please contact the Technical Service Center of Company.
-

Directory

Article 1.Safety Instruction	4
1.1 The indication of safty symbol	5
1.2 Caution of electric	5
1.3 Caution of Installation and connection item	5
1.4 Caution of Operation	6
1.5 Caution of enviroment	7

Article 2 Introduction to Products	8
2.1 Checking after you got the Inverter	9
2.2 Symbol and type reference	9
2.3 specification	10
2.4 standard technique	11

Article 3 Installation and Connection	12
3.1 Installation of Inverter	13
3.2 Connecting of Inverter	14

Article 4 Control panel and display	21
4.1 Control panel	22
4.2 Operation of control panel	24
4.3 The content of dispay	27

Article 5 Run-in test	28
5.1 Run-in test	29
5.2 Operation of run	30

Directory

Article 6 Reference on Function Data	31
6.1The fleet of function data	32
6.2Detail reference of function data	39

Article 7 Trouble diagnosis and treatment	58
7.1Trouble and the reason	59
7.2 Familiar trouble diagnosis and treatment	60
7.3Motor abnormity and treatment	64

Article 8 Repairing and Maintenance	66
8.1Repair and maintain	67
8.2 Transport and deposited	68

Article 9 Exterior dimension and installing dimension	69
9.1 Exterior dimension and installing dimension	70

Article 10 Quality guarantee	72
10.1Quality guarantee	73

Appendix	
Appendix AOperation panel	74
Appendix B Trig unit .brake resistance	75
Appendix C Reference of surrounding equipment	76

Article 1

Safety Instruction

1.1	Indications of Safety Symbols	5
1.2	Cautions for Electrical Work	5
1.3	Cautions for Installing and Wiring	5
1.4	Cautions for Operation	6
1.5	Cautions for Working Ambient	7

This article mainly introduces cautions for installation, wiring, operation, operating conditions and electrical work. To avoid any errors that may result in damage to equipment or injury to personnel, do read carefully all of the instructions in this article.

1.1 Indications of Safety Symbols

To use and operate the inverter correctly, do read and clearly understand the following symbols in this manual before installing and operating it, and follow the instructions exactly.

 **WARNING:** This symbol calls your attention to avoid any incorrect operation that can result in serious damage to the equipment or death to personnel.

 **CAUTION:** This symbol calls your attention to avoid any incorrect operation that can result in damage to the inverter or other equipment.

1.2 Caution of electric

- The ground terminal must be reliably, properly and independently grounded to ensure security.
- The electronic components inside the inverter are very sensitive to static. Do keep your hands off the circuit board and never put foreign matter inside the inverter before taking antistatic measures. Otherwise, there is an equipment failure.
- Do not touch any active components in the inverter, for high voltage remains in it when the indicator light is ON after the power cut.

1.3 Cautions for Installation and connection

- The installation and connection of inverter should be operated by qualified electricians. Read this instruction manual in detail before installing and wiring.
- Wait at least five (5) minutes after turning OFF the power supply before wiring. Otherwise, there is the danger of electric shock.
- Be sure that the main circuit is correctly wired. Three-phase 200V or 400VAC input power must be connected to the terminals labeled R, S and T. Single phase input power must be connected to terminals labeled L1 and L2. The output power should be connected to terminals marked U, V and W. Otherwise, there is serious damage to the inverter.
- The output terminals (U, V, W) should be connected to the motor directly. Do not install electromagnetic contactor, switch, capacitor or surge suppressor between the terminal and the motor. Otherwise, it may result in inverter failure and device damage.
- Be sure to install the inverter on flame-resistant material such as a steel plate, for heat will be produced during the running of inverter. The surface of plate must be flat or even. Otherwise, the base of inverter might be easily broken.
- Be sure to install an exhaust fan or other ventilation equipment in the case in which the inverter is installed, so as to keep the ambient temperature less than +40°C.

1.4 Cautions for Operation

- Be sure to turn ON the input power supply only after closing the case. While the inverter is energized, be sure not to open the case. Otherwise, there is the danger of electric shock.
- Be sure not to operate the inverter with wet hands. Otherwise, there is the danger of electric shock.
- Be sure not to disconnect power or install an electromagnetic contactor between inverter and power to start or stop the inverter. Otherwise, it could reduce the service life of inverter.
- If the Retry Mode is set, please put a warning sign like “KEEP CLEAR” in an eye-catching place before the equipment to avoid sudden restart of the equipment after a trip stop that may result in injury to personnel.
- Set an appropriate status of forward or reverse according to your specific requirements. Otherwise, the motor may counter rotate.
- Do not modify the set parameter value for inverter if there is no special requirement, for the factory default setting has been done properly. Otherwise, it may cause damage to the inverter or equipment due to error parameter.
- The heat sink base, the braking resistance and other heating elements will have high temperature in running. Be careful not to touch them.
- The operation of inverter can be easily changed from low speed to high speed. Be sure to check the capability and limitations of the motor before operating the inverter. Otherwise, the motor may get burned.

1.5 Cautions for operating ambient

It is strongly recommended not to use the inverter in the following places that have:

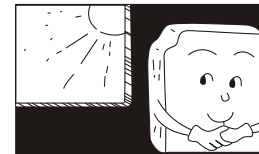

direct exposure to sunlight

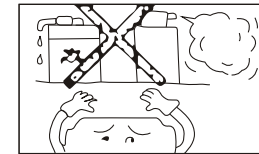

corrosive gas and liquid

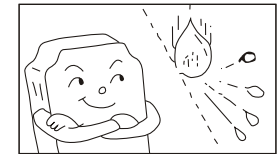

gasoline and air mist

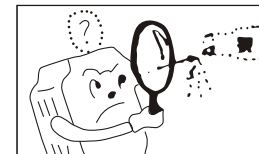

Salt



high humidity with relative humidity > 90% or dew condensation



iron dust or foam

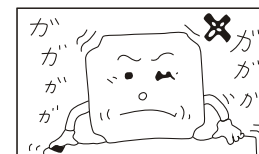

strong vibration

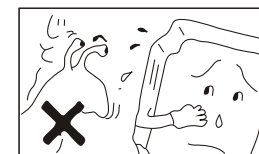

extreme cold



over heat



Electromagnetic wave (i.e., Welding machine)

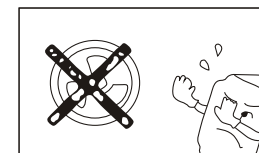

radioactive material

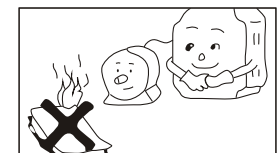

flammable material

Article 2

Introduction to Products

2. 1	Check the inverter immediately after you get it	9
2. 2	Instruction on the nameplate and type	9
2.2.1	Instruction on the nameplate	9
2.2.2	Instruction on the nameplate	9
2. 3	Product Specifications	10
2. 4	Standard Technical Specifications	11

This article is a brief introduction of Inverter, main items are name plate reference, type reference, the general technique and the checking item after you got the Inverter.

2.1 Checking after you got the Inverter

The Inverter has been inspected strictly and keep the Inverter shock resistant, crash resistant, maybe the accident happened in the transport, so please open the carton and check it as soon as you got the products.

Checking item:

1. check the Inverter destroyed or not.
2. Packing box concluding a piece of Inverter, a brochure.
3. Check the name plate, be sure that the Inverter is your ordered.

2.2 The reference of name plate and type

2.2.1 Reference of name plate

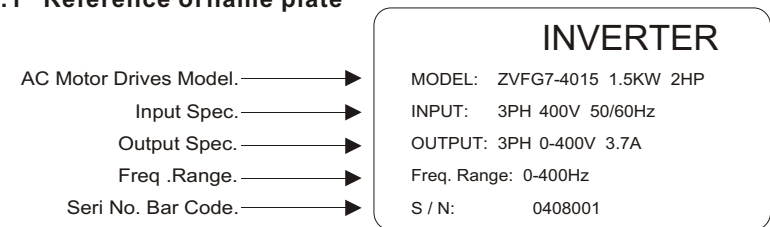

2.2.2 Reference of type

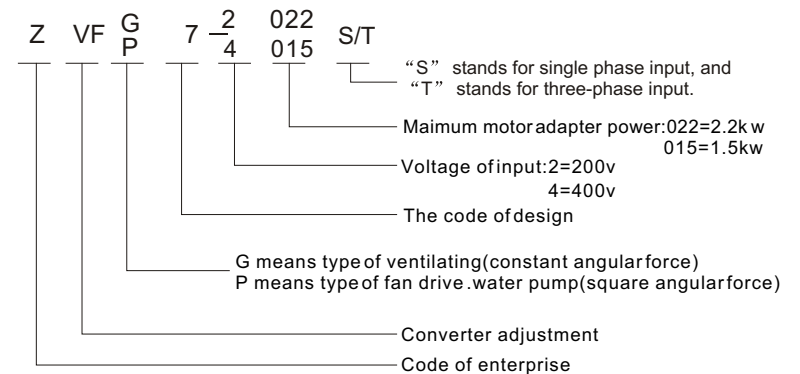

2.3 Product Specifications

Type of Inverter		Input Voltage (v)	Max Adapter Moter(kw)	Rated output current(A)
means type of ventilating	means type of fan drive .water pump			
ZVFG7-2007T/S		220	0.75	4
ZVFG7-2015T/S		220	1.5	7
ZVFG7-2022T/S		220	2.2	10
ZVFG7-2037T/S		220	3.0	13
ZVFG7-2055T		220	5.5	25
ZVFG7-2075T		220	7.5	33
ZVFG7-2110T		220	11	49
ZVFG7-2150T		220	15	65
ZVFG7-2185T		220	18.5	75
ZVFG7-2220T		220	22	90
ZVFG7-4007T		380	0.75	2.5
ZVFG7-4015T		380	1.5	3.7
ZVFG7-4022T		380	2.2	5
ZVFG7-4037T		380	3.7	8.5
ZVFG7-4055T		380	5.5	13
ZVFG7-4075T		380	7.5	18
ZVFG7-4110T	ZVFP7-4110T	380	11	24
ZVFG7-4150T	ZVFP7-4150T	380	15	30
ZVFG7-4185T	ZVFP7-4185T	380	18.5	39
ZVFG7-4220T	ZVFP7-4220T	380	22	46
ZVFG7-4300T	ZVFP7-4300T	380	30	58
ZVFG7-4370T	ZVFP7-4370T	380	37	75
ZVFG7-4450T	ZVFP7-4450T	380	45	90
ZVFG7-4550T	ZVFP7-4550T	380	55	110
ZVFG7-4750T	ZVFP7-4750T	380	75	150
ZVFG7-4930T	ZVFP7-4930T	380	93	170
ZVFG7-41100T	ZVFP7-41100T	380	110	210

2.4 Standard Technical Specifications

Item		Reference
Input	Input voltage	Single phrase 200V ±15% three phrase 400V±20% Three-phase 200V±15%
	Input frequency	50/60 Hz±5%
Output	Output voltage	Three phase 0~input voltage
	Output frequency	0.1~400Hz
Capacity of overload		ZVF-G7:150%rated current one minute ZVF-P7: 120%Rated current one minute
Control function	Adjustment	Space voltage complexor SVPWM control
	Output Accuracy	Max output frequency +0.1%
	Output frequency resolution factor	Data setting:0.1Hz analog setting:Max frequency *0.1%
	angular force lifting	0~30%
	angular force compensation	0.0~5.0 Hz
	Speed/release time	Straight and S curve line ,eight section speed/release the time.set range 0.1~999.9s
	PWM carrier frequency	1~12KHz
	V/F curve line	Set the V/F curve arbitrarily
	Mutistep run	DC brake frequency 0.0~25.0Hz.torque 0~30%.time 0.0~25.0S
	Run function	Run control
Frequency setting		Panel ▲▼key ,analog voltage or potentiometer . analog current .terminal exterior lift/down
Input signal		Positive. Reverse command,multi speed command,run command, accident input,reset command,count input and so on.
Output signal		Accident warning output (250V/2A contact),open electric pole output
Other function		Diagram run.PID.restart after transient stop,restart after accident, frequency down up,data locking.crawl function.absorbing function and so on.
Protection function		Overcurrent protection.over voltage protection.under voltage protection. overload protection.over heat protection.output short circuit protection
Display	Run	Output frequency.output current.output voltage.DC bus bar voltage.speed . PID feedback.PID aim data.counter data
	accident	Overc urrent.over voltage.under voltage.overload.over heat.output short circuit.system abnormality.fault of diagram code.accident exterior.depsoit fault.data fault and so on
Environment	Exterior connecting meter	Analogue frequency teller.analogue ammeter(ImA).analogue volmeter(DC10V)
	Work place	Indoor,avoid the sunshine,without dust ,without combustible and corrosion gas
	altitude	Below 1000 meters
	Temperature.humidity	Temperature:-10 degree~+40 degree humidity:20%~90%RH(with water drip)
	shake	Below 0.5G
Deposit temperature	-20 degree~+60 degree	
Function	Protect grade	IP20
	Manner of cooling	Force fan cold

Article 3

Installation and Connection

3.1	Installation of Inverter	13
3.1.1	Caution of enviroment	13
3.1.2	Caution of installation	13
3.1.3	Install space and direction	13
3.2	Connecting of Inverter	14
3.2.1	Standard connecting diagram	14
3.2.2	key electric way connecting	15
3.2.3	connecting of control	18
3.2.4	The list of complement electricity	20

Good or bad enviroment is the necessary item for the Inverter. In that case, be sure to install it correctly. The installation job are charge for the electrician. Please pay attention to the caution item.

3.1 Installation of Inverter

3.1.1 Caution of enviroment

- Under the 1000meters of altitude
- Temperature.humidity: Temperature:-10 degree~+40 degree humidity: 20%~90%RH(with water drip)
- Without dirct sun shine.no water drip .no evapour.dust and oil place
- Indoor,avoid the sunshine,without dust ,without combustibile and corrosion gas
- No granule of metal or foam of metal place
- No shake .no electro magnetic interference place

3.1.2 Caution of installation

- ⚠ **Caution:** The board must be plat,otherwise it will make the base broken off .
- ⚠ **Caution:** There will be heat when the Inverter run,so it is better to install the Inverter on the steel board and other fire-resisted material.
- ⚠ **Caution:** If you install the Inverter in the cabinet,please install the pan in additional,be sure to keep the enviroment below+40degree;

3.1.3 Install space and direction

- In order to keep cool the Inverter well and maintain well,you would better keep the enough space for the Inverter and install it vertically.
- If you install two piececs in a cabinet,please install it in horiz ontal dioposition (No.2 picture);if it is neccessary to install together up and down,in order to avoid the overheat,please add a division board(No.3 picture)

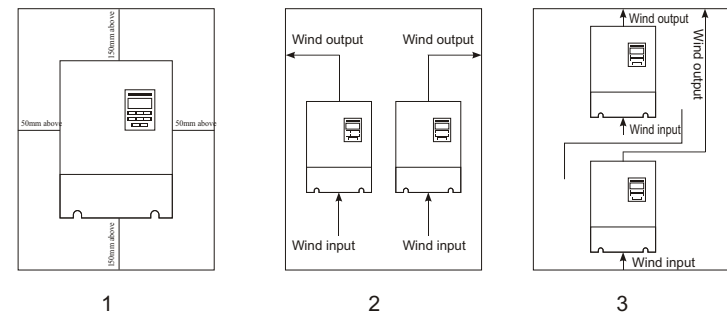

3.2 Inverter connecting

3.2.1 Standard connecting diagram

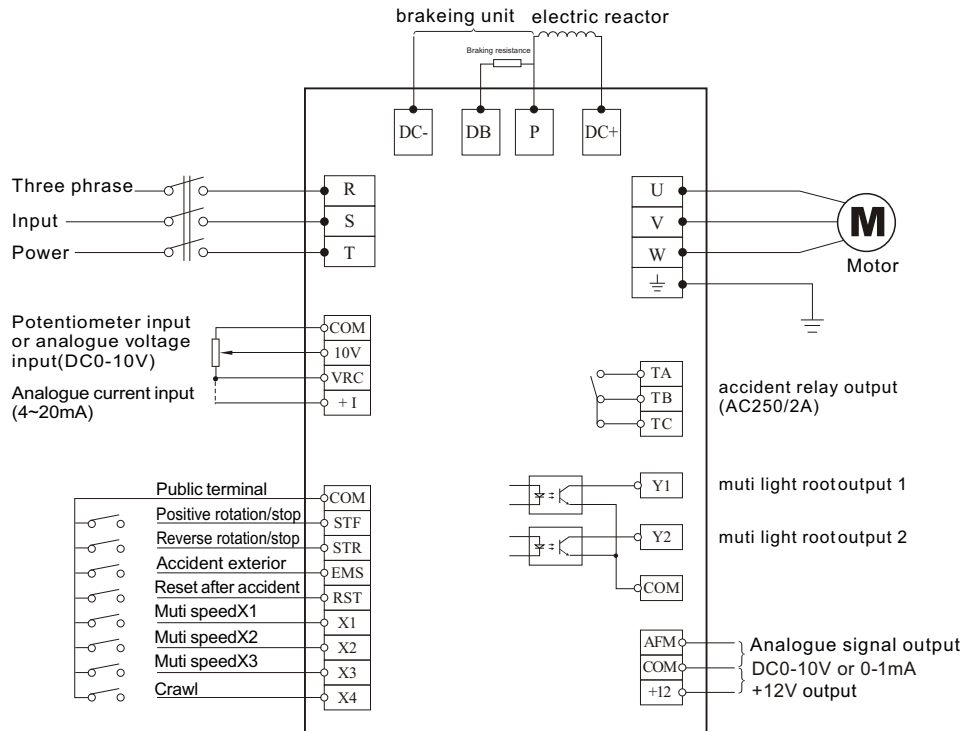

Note: (1) The factory set the connecting diagram;
 (2) ●Indicate the key terminal, ○indicate the control terminal

3.2.2 Key electric connecting

■ Caution of the key electric conetning

- ⚠ **Dangerous:** Be sure the key electric connecting correct. Three-phase 200V or 400V input have to connect R.S.T terminal blocks, (single phrase 220V input have to connect the terminal block L1.L2),output have to connect the terminal block U.V.W, otherwise it will destroy the Inverter.
- ⚠ **Dangerous:** It is forbidden to connect the wire when the Inverter is in use.Be sure to operate it when cut off the power after five minutes .
- ⚠ **Attention:** The terminal block for output (U.V.W) must be connect to the motor directly,do not install magnetic starter .switchgear. power capacitor and surge protetsive device with it.other wise it will destroy the Inverter;
- ⚠ **Attention:** It only switching the motor or power after the Inverter stoped.
- ⚠ **Attention:** It is forbidden earth other currentloaded equipment.Be sure earth seprately and the wire must be as short as possible.
- ⚠ **Attention:** It must be earth well,avoid the electric shock . the fire or reduce the sound.It is forbidden that it connect a circuit with many Inverter earth.

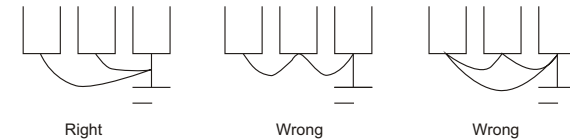

- ⚠ **Attention:** Earth has match the international requirement.
- ⚠ **Attention:** Be sure to connect the wire with the press terminal, keep the connecting contact.
- ⚠ **Attention:** After completed the connecting ,please check it whether impurity in it,and be sure that the connecting correct. No leakage and wrong connecting.No circuit between the terminal and the connector.

■ The key terminal

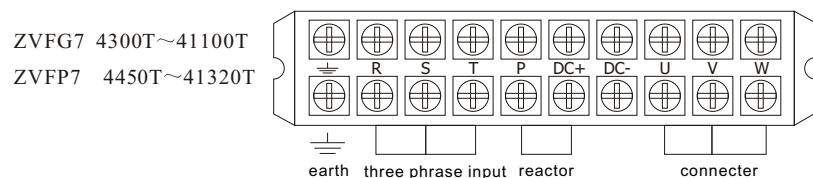
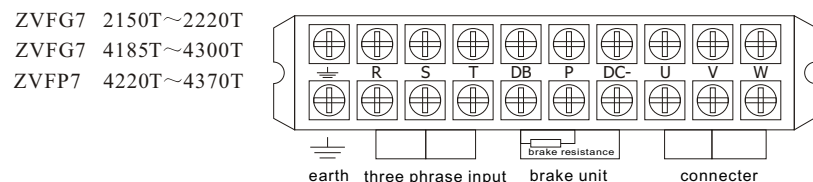
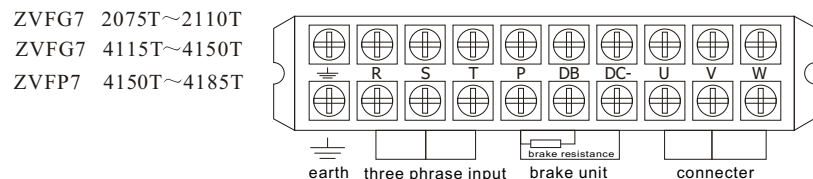
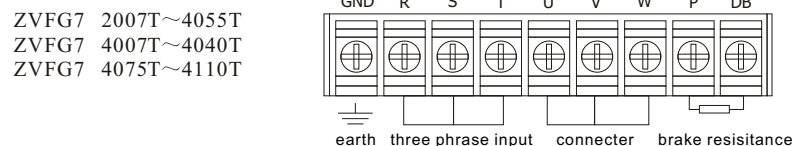
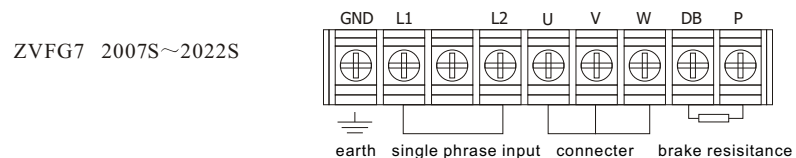

■ Main circuit terminal reference

Mark	Title of terminal	Function reference
R、S、T	Input terminal of Inverter	Connect the Three-phase
L1、L2	Input terminal of Inverter	Connect the single phase
U、V、W	Output terminal of Inverter	Connect the three phrase motor
BR+、BR-	Brake terminal	Connect exterior resistance of braking
P DB	Brake terminal	Connect exterior resistance of braking
P DC-	DC bus bar terminal	Connect external braking unit
P DC+	External reactor terminal	Connect the DC reactor external
⊥	Earth terminal	earth

■ Reference of main circuit connecting

- Three phase input terminal (R.S.T) connect freely,
- Output terminal (U.V.W) connect the three phase motor,if you find the rotating reverse ,please adjust the two phrase arbitrary,
- The Inverter below 15KW concluding the brake unit,if you need to connect the brakeing resistance,please connect the it between DB and P or BR+ and BR-
- The Inverter with out the internal brake unit,in order to increase the braking ability ,it can be increase a braking unit between terminal P and DC+.
- If the wire between the motor and the Inverter is too long,especially the low frequency out put,the rotate torque will fall down or the accident will happened in the condition of the components act error.So it would better that the length no exceeding 50 meters(200V is 30 meters),other wise please consider plus output side AC reactor.
- The connecting which between Inverter and the motor would better put in metal pipe.

3.2.3 Connecting of the control circuit

■ Caution of the connecting circuit

- ⚠ **Attention:** Control circuit must be absorb green wire and twisted pair wire, and it must be connect to the key circuit .staving circuit separatly. If the control circuit line must be cross the the key circuit and other control line , it must be vertical cross connecting.
- ⚠ **Attention:** Control circuit is easily disturbed by the enviroment, so the distance must be short (Generally no exceeding 30 meters). Analogue voltage .Ampere and potentiometer input no exceeding 20 meters.
- ⚠ **Attention:** In the condition of contact ,please use the reliable contact point.
- ⚠ **Attention:** Be sure to install the surgue absorbing between the magnetic coil which is occuring voltage surge ,it eliminates the voltage surge that avoid the error action.
- ⚠ **Attention:** The wire for control circuit used to 0.75mm²

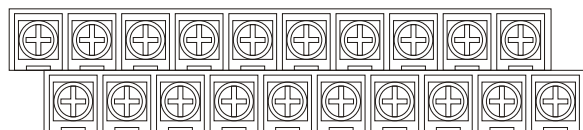

TA	TB	TC	X1	X2	X3	X4	EMS	RST	+12V
Y1	Y2	STF	COM	STR	10V	VRC	COM	+I	AFM

■ Reference for the terminal of control circuit

Type	Mark	Title of terminal	Reference of function
Input signal	COM	Public terminal	-----
	STF	Positive rotata/stop	Positive rotate after connecting COM,break stop
	STR	Reverse/stop	Reverse rotate after connecting COM,break stop
	EMS	Accident exterior	Connecting COM,Inverter quick output
	RST	Accident reset	Connecting COM,accident reset
	X1	Multi-speed 1	Connect or break X1.X2.X3with the COM, can realize switch run of eight section
	X2	Multi-speed 2	
	X3	Multi-speed 3	
X4	Crowl function	Connecting COM,crowl run	
Output signal	TA、TB、TC	Accident relay output	TA-TB close when the accident protecting,TA-TB breaking(Rated contact campacity AC250V 2A)
	Y1、Y2	Multi light output	Look at "F098.F099"about the multi light input chioce(light output DC24V 50MA)
Analogue input	10V	Reactor input	Connect the potentionmeter and terminal of VRC. COM,can Set frequency(potentionmeter 5-10k)
	VRC	Analogue signal input	Connect analogue input voltage with the terminal COM,can set frequency(analogue voltage signal DC0-10V)
	+I	Analogue signal input	Connect analogue input voltage with the terminal COM,can set frequency(analogue Ccurrent signal 4~20mA)
Analogue output	AFM	Analogue signal input	Connect voltmeterDC0~10v or Ampmeter0~1mA, corresponding output 0~Max frequency
	+12V	Power output	Output +12V power between terminal of COM

Note: the list are the factory set

3.2.4 Directory of complement electric

Complement of circuit breaker.magnetic starter and the width of wire with the Inverter

Title	Max adapter Motor(KW)	Key circuit wire(mm2)	Control line (mm2)	Circuit breaker (A)	Contactor (A)
-2007T/S	0.75	2.5	0.75	10A	10A
-2015T/S	1.5	2.5	0.75	16A	16A
-2022T/S	2.2	4	0.75	20A	25A
-2037T/S	3.0	6	0.75	32A	40A
-2055T	5.5	10	0.75	50A	40A
-2075T	7.5	10	0.75	63A	63A
-2110T	11	16	0.75	100A	100A
-2150T	15	25	0.75	125A	160A
-2185T	18.5	25	0.75	160A	160A
-2220T	22	35	0.75	200A	160A
-4007T	0.75	1.5	0.75	10A	10A
-4015T	1.5	2.5	0.75	10A	10A
-4022T	2.2	2.5	0.75	10A	16A
-4037T	3.7	4	0.75	16A	16A
-4055T	5.5	6	0.75	32A	25A
-4075T	7.5	6	0.75	32A	40A
-4110T	11	10	0.75	50A	40A
-4150T	15	10	0.75	63A	63A
-4185T	18.5	16	0.75	80A	63A
-4220T	22	16	0.75	100A	100A
-4300T	30	25	0.75	125A	160A
-4370T	37	25	0.75	160A	160A
-4450T	45	35	0.75	200A	160A
-4550T	55	35	0.75	200A	250A
-4750T	75	50	0.75	250A	250A
-4930T	93	50	0.75	315A	400A
-41100	110	70	0.75	400A	400A

Article4

Control panel and display

4.1	Control panel	22
	4.1.1 Figure of panel	22
	4.1.2 Reference of key on panel	23
4.2	Operation of control panel	24
	4.2.1 Data modify method	24
	4.2.2 Example of data modify	25
4.3	The content of display	27

This article are main introduce the figure of panel .key. operation and the display,the user can understand the control panel ,it is suitable for you operate it correctly.

4.1 Control panel

4.1.1 Figure of panel

■ Control panel(1)

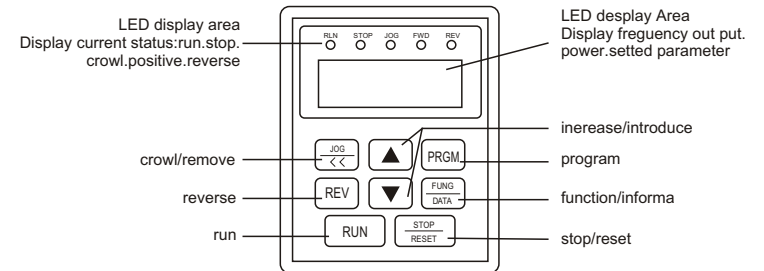

■ Control panel(2)(with potentiometer)

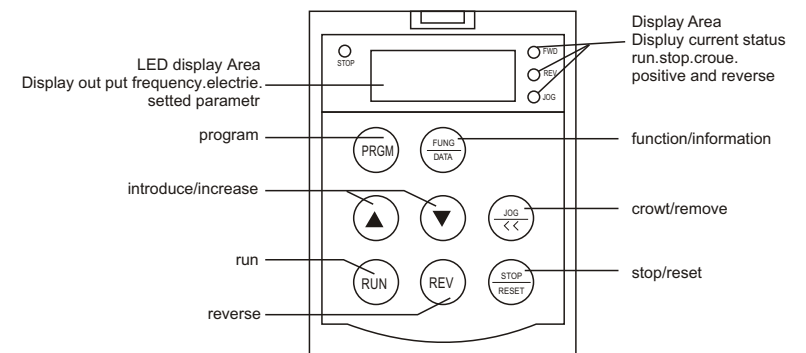

4.1.2 Illustration of key

■ Illustration of panel

Symbol	Title	Reference of function
	RUN	Press it start run(If set F001 as the exterior control, it is expiry)
	Start reverse rotate	Press it start reverse run(If set F001 as the exterior control or F004 is 1,it is expiry)
	Stop/reset	Press it stoprun(If set F001 as the exterior control,it is expiry).After accident warning,press this can reset.
	Set	Press this enter into the setting situation,after you completed modify,press this can recede from the setting situation.
	Function/display	In the condition of setting,press it as the confirm code, after completed the data modify,press it as the deposit of the data.In the condition of run,press this as display, such as output frequency,speed.output current and so on.
	Increase	In the setting condition,press this can increase code of function .data of parameter.In run or stand-by ,press this can increase the frequency of run.
	Reduce	In the setting condition,press this can reduce code of function .data of parameter.In run or stand-by ,press this can reduce the frequency of run.
	Crawl	In the condition of stand-by(F021=1),press this operate crawl action.In the condition of setting,when you want to modify the data,press this can choose the position of modify data.

■ Illustration of indicator

Title of indicator	Illustration
● Stop	After the Inverter connect the power and it is not start the indicator is lighting .
● Positive	After the Inverter connect the power and press the positive key,the indicator is lighting.
● Reverse	After the Inverter connect the power and press the reverse key,the indicator is lighting.
● Crawl	After the Inverter connect the power and press the crawl key,the indicator is lighting.

4.2 Control panel operation

4.2.1 Method of the data modify

If you need to modify the data,first enter into the function code which will be modified,then reset the data,the process as following:

Subsequence	Operation	Illustration
1	press	Display F000,enter into the function setting.
2	press	Adjust to the function data which will be modified.
3	press	Display =×××,enter the data setting situation
4	press	Reset the parameter value according your requirement.
5	press	Display the END quickly,deposit the data,then display the function code F×××
6	press	Recede the setting condition,turn back to the stand by or run condition.

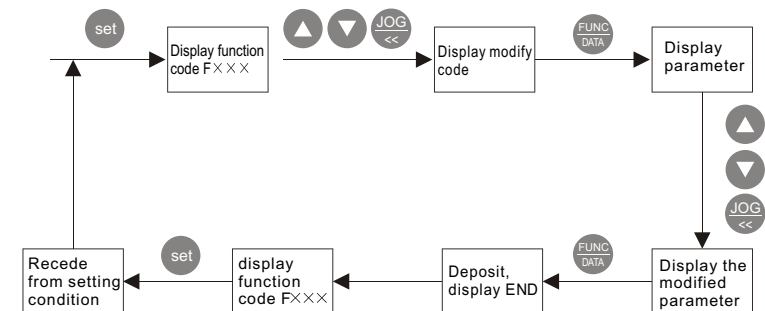

4.2.1 Example of the data modify

No.1Example :Change output frequency 50HZ to 25HZ

Subsequence	Operation	Illustration
1	press	Display F000,enter into the function setting.
2	press	Display=500,enter into parameter modified.
3	press	Continue press this untill display=25.0
4	press	Display the END quickly,deposit the data,then display the function code F000
5	press	Recede the setting condition,turn back to the stand by,display H25.0

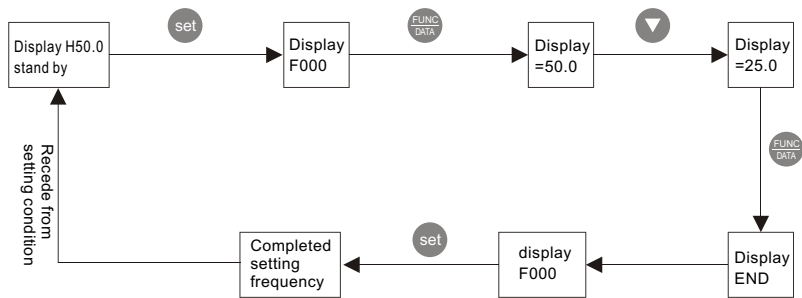

No.2Example :Recovery the factory data(data initialize)

Subsequence	Operation	Illustration
1	press	Display F000,enter into the function setting.
2	press	Press four times,display F004.
3	press	Press one time,0 in the between is flashing
4	press	Press one time,display F014.
5	press	Press one time,the forward 0 is flashing
6	press	Press one time,display F114.
7	press	Display=0,enter into setting status
8	press	Press one time,display=1
9	press	All display data flashing one time,then display H × × × ,completed recover factory data

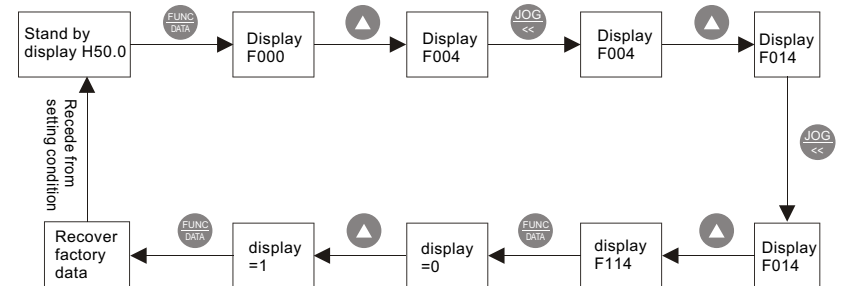

4.3 Content of display on the control panel

Inverter in the stand by status,when you press "Display"key,display cycle as follows.

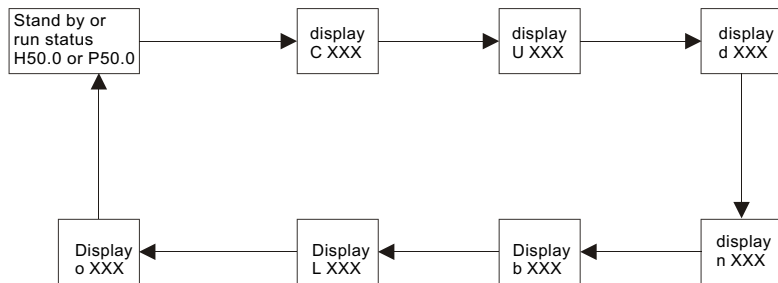

Code	Illustration
H	Inverter in the status of stand by,display frequency of it
P	Inverter in the status of run,display frequency of it
C	Display the outputcurrent of the run
U	Display the outputvoltage of the run
D	Display the AC voltage of bus bar wire
N	Display the present speed of the Inverter
J	Display the feedback data when PID run
b	Display the data setted when PID run
L	Display the data of the counter
o	Display the temperature of the module

Article 5

Run-in test

5.1 Run-in test 29

5.1.1 Caution of the safty 29

5.1.2 Checking before the Run-in test 29

5.1.3 Run-in test 29

5.2 Operation of run 30



5.2.1 Caution of the safty run 30

5.2.2 Operation of run 30

This article are introducing the caution of operation,it is including the checking item before run .the process of Run-in test and the several operation method.

5.1 Run-in test

5.1.1 Caution of the safty before Run-in test



-  **Dangerous:** Install well the shell when it run,do not dismount the shell when it runs,avoid the electric shock.
-  **Attention:** Before run-in test ,it must be unload run,avoid the destroy by the error action.







5.1.2Checking before run-in test

Be sure to check and confirm before run-in test:

- Ensure the environment and installation according to the clause 3. 1
- Ensure the connect correctly, especially the input has to connect to terminal R. S. T, output U. V. W connect to the motor.
- Ensure Inverter earth well.
- Ensure all of the switches are in close and break status,avoid the error action when it is run.
- Ensure no short circuit or ear short circuit.
- Ensure all the terminals .connectors and screws are tacking.
- Ensure the motor run unload.







5.1.3 Run-in test

After checking and confirm by the clause 5.1.2,you can run-in test .You would better choose   key control the the run manner.Run-in test in process as follows:

Subsequence	Operation	Illustration
1	Close the switch, Inverter run	In status of electric ,Inverter is in status, display H×××,interior fan start work
2	Press   key untill frequency display P5.0	If itdisplay H5.0 ,ignore this process
3	Press start  key	Motor start ,Inverter display increase from P0.0 to 5.0
4	Check : 1.Whether motor run well; 2.Whether noise and abnormality; 3.whether the correct direction	If abnormality happened,please stop the run and cut off the electric ,then check the accident, restart it after repair it.If you found the motor run reverse against your requirement,change each two of connection U.V.W is ok.If everything is ok,operate the next step.
5	Press Up  key continously untill frequency display is P50.0	Motor speed up ,frequency display increase from P5.0 to P50.0;if everything is ok,operate the next step.
6	Press Up  key continously untill frequency display is P0.0	Motor speed down ,frequency display reduce from P50.0 to P0.0;if everything is ok,operate the next step.
7	Press stop  key	Inverter stop to output,motor stop rotate,run-in test finish.Generally,please repeat servral times. from the first step to the seventh step

5.2 Run operate

5.2.1 Cautions in runing status

-  **Dangerous:** Install well the shell when it run,do not dismount the shell when it runs,avoid the electric shock.
-  **Dangerous:** Do not operate the Inverter by the damp hand,avoid electric shock.
-  **Dangerous:** When the Inverter set the function of restart after power off,please put a warning sign "Do not approach" beside it. Otherwise it will prevent the human after the start abruptly.
-  **Dangerous:** The Inverter has install the radiator and exterior brake resistance,so please do not touch it.It is heat.
-  **Attention:** If the Inverter set in high speed status,please confirm it is able before.
-  **Attention:** Attention:Do not change the setted parameter if you have not special requirment, because it is been fixed by the factory.Avoid the distroy by the change.

5.2.2Run operation

In the status of run,setting frequency can adjust directly on the line. All function of Inverter depend on the the parameter setted,this style of Inverter is make up by function code 001~116,detail as directory 6.1.The parameter displayed is the factory parameter,user can adjust it by the private requirement.Because the parameter are relevant parameter,when user modify some parameter,it better modify the related parameter.If user modify error or disorder the parameter,please initialize parameter according examples 2 by clause 4.2.2.(Initialize factory parameter)

Article6

Function parameter illustration

6.1 Function parameter directory 32

6.2 Detail illustration of function parameter 39

This article express the function parameter of Inverter.
When user set the function parameter, please read it carefully,
in that case, user can avoid the error set and the accident.

6.1 Directory of function parameter

Function of control

Function code	Title of function	Range of set	Factory parameter	Note
F000	Run frequency	0.0~max frequency(F004)	5.0Hz	
F001	Choice of runing control	0: panel control (positive start,reverse start,stop) 1: Exterior Terminal control (positive start/stop, reverse/stop) 2: Exterior Terminal control (positive start/stop, reverse/positive) 3: Exterior Terminal control (positive start, reverse start,stop)	0	
F002	Choice of frequency setting	0: panel up/down 1: Panel reactor 2: Exterior reactor or exterior voltage 0~10VDC 3: Exterior input current4~20mA 4: Exterior up or down	0	
F003	Choice of stop	0: reduce stop 1: free stop 2: immediate AC brake 3: Exterior free stop	0	

V/F curve setting

Function code	Title function	Range of setting	Factory parameter	Note
F004	Highest frequency	Lowest frequency~400.0Hz	50.0Hz	
F005	High voltage	200V: 160.0V~240.0V 400V: 320.0V~480.0V	220V 380V	
F006	Rated motor frequency	(F007)~400.0Hz	50.0 Hz	
F007	Medium frequency	Lowest frequency(F009)~Highest frequency(F004)	25.0 Hz	
F008	Medium voltage	Lowest voltage(F010)~99% rated voltage	50%	
F009	Lowest frequency	0.0~10.0 Hz	0.0 Hz	
F010	Lowest voltage	0~10%rated voltage	1%	

Basic function

Function code	Title of function	Range of setting	Factory data	Note
F011	Highest frequency corresponding input	0~100%	100%	
F012	Lowest frequency corresponding input	0~100%	1%	
F013	Rated current of	50.0~110%	100%	

Basic function(continous upstairs)

Function code	Title function	Range of setting	Factory parameter	Note
F014	Toplimit frequency	Lowlimit frequency F015~400HZ	50.0 Hz	
F015	Lowlimit frequency	0.0~ toplimit frequency(F014)	1.0 Hz	
F016	start frequency	0.0~10.0Hz	1.0 Hz	
F017	Start delay time	0.0~60.0S	0.5S	
F018	Speed time	0.1~999.9S	10.0S	
F019	Reduce time	0.1~999.9S	10.0S	
F020	Increase/reduce curve	0: straight line 1: S curve	0	

Crawl function

Function code	Title function	Range of setting	Factory parameter	Note
F021	Choice crawl	0:the function expiry 1:the function validity	0	
F022	crawl frequency	Lowest frequency (F009)	5.0Hz	
F023	Time speed up	0.1~999.9S	5.0s	
F024	Time speed down	0.1~999.9S	5.0s	

Multi speed run

Function code	Title function	Range of setting	Factory parameter	Note
F025	Second frequency	Highest frequency(F004)	5.0Hz	
F026	Second speed up time	0.1~999.9S	10.0S	
F027	Second speed down time	0.1~999.9S	10.0S	
F028	Third frequency	Highest frequency(F004)	10.0Hz	
F029	Third speed up time	0.1~999.9S	10.0S	
F030	Third speed down time	0.1~999.9S	10.0S	
F031	Fourth frequency	Highest frequency(F004)	20.0Hz	
F032	Fourth speed up time	0.1~999.9S	10.0S	
F033	Fourth speed down time	0.1~999.9S	10.0S	
F034	Fifth frequency	Highest frequency(F004)	30.0HZ	
F035	Fifth speed up time	0.1~999.9S	10.0S	
F036	Fifth speed down time	0.1~999.9S	10.0S	
F037	Sixth frequency	Highest frequency(F004)	40.0HZ	

Multi speed run

Function code	Title function	Range of setting	Factory parameter	Note
F038	Sixth speed up time	0.1~999.9S	10.0S	
F039	sixth speed down time	0.1~999.9S	10.0S	
F040	Seven frequency	Highest frequency(F004)	50.0HZ	
F041	Seven speed up time	0.1~999.9S	10.0S	
F042	Seven speed down time	0.1~999.9S	10.0S	
F043	Eighth frequency	Highest frequency(F004)	50.0HZ	
F044	Eighth speed up time	0.1~999.9S	10.0S	
F045	Eighth speed down time	0.1~999.9S	10.0S	

Program run

Function code	Title function	Range of setting	Factory parameter	Note
F046	Mode of program run	0: expiry 1: Stop after single cycle run 2: Run cycle 3: Maintain the last frequency after single cycle run	0	
F047	Program run coefficient	1~100	1	
F048	Program run at 1 temporal	0~999.9S	0	
F049	Program run at 1 direction	0:positive 1:reverse	0	
F050	Program run at 2 temporal	0~999.9S	0	
F051	Program run at 2 direction	0:positive 1:reverse	0	
F052	Program run at 3 temporal	0~999.9S	0	
F053	Program run at 3 direction	0:positive 1:reverse	0	
F054	Program run at 4 temporal	0~999.9S	0	
F055	Program run at 4 direction	0:positive 1:reverse	0	
F056	Program run at 5 temporal	0~999.9S	0	
F057	Program run at 5 direction	0:positive 1:reverse	0	
F058	Program run at 6 temporal	0~999.9S	0	
F059	Program run at 6 direction	0:positive 1:reverse	0	
F060	Program run at 7 temporal	0~999.9S	0	
F061	Program run at 7 direction	0:positive 1:reverse	0	
F062	Program run at 8 temporal	0~999.9S	0	
F063	Program run at 8 direction	0:positive 1:reverse	0	

PID function

Function code	Title function	Range of setting	Factory parameter	Note
F064	PID mode choice	0:PID function expiry 1: PID validity expiry	0	
F065	PID aim parameter	0: Panel key 1: Panel reactor 2: Exterior reactor or analogue voltage 0~10v 3: Exterior analogue current 4~20mA 4: Exterior lift/fall lift	0	
F066	PID original parameter	0: Exterior voltage 1: Exterior current	1	
F067	PID max aim parameter	0~9999	1000	
F068	Max parameter feedback	0~100%	100%	
F069	PID minimum parameter	0~9999	0	
F070	Min parameter feedback	0~100%	0	
F071	Proportion gain	0.00~99.99	1.00	
F072	Integral time	0.0~99.9S	1.0	
F073	Differential time	0.0~99.9S	1.0	
F074	Feedback coefficient	0~200%	100%	

Ac brake function

Function code	Title function	Range of setting	Factory parameter	Note
F075	AC brake time	0.0~25.0S	0.3 s	
F076	AC brake frequency starting	0.0~25.0HZ	3.0HZ	
F077	AC brake torque	0~30%	4%	

Counter function

Function code	Title function	Range of setting	Factory parameter	Note
F078	Counter mode	0:Expiry 1:Mode of up counter 2: Mode of down counter	0	
F079	Counter parameter	0~9999	1	

Multi-speed run (Continuous)

Function code	Title function	Range of setting	Factory parameter	Note
F080	Counter coefficient	0~9999	1	
F081	Counter dealing	0: Stop count ,close output 1: Stop count ,continuous output 2: Restart count,close output 3: Restart count,continuous output	0	

Special function

Function code	Title function	Range of setting	Factory parameter	Note
F082	AVR function	0:Expiry 1:validity	1	
F083	Torque lift	0~30%	4%	
F084	Slip compensation	0.0~5.0Hz	0.0 Hz	
F085	Carrier wave frequency	1~12K Hz	5	
F086	Restart after Instant stop	0:Expiry 1: Quick run after electric recover 2: Quick start after electric recover	0	
F087	Frequency arrive setting	0.0~400.0Hz	0.0 Hz	
F088	Analogue input gain	0.0~200%	100%	
F089	Analogue output choice	0:Analogue cymometer 1: Analogue Ammeter 2: Analogue Voltmeter	0	
F090	Analogue output gain	50~150%	100%	
F091	Starting display choice	0:Output frequency 1: Output current 2: Output voltage 3:AC bus bar voltage 4:Motor speed 5:PID parameter feedback 6:PID aim parameter 7:Parameter of count 8:Temperature of module	0	
F092	Speed coefficient	0.01~99.99	30.00	

Multi terminal

Function code	Title function	Range of setting	Factory parameter	Note
F093	X1 function choice	0:Multi speed 1 1: Multi speed 2	0	
F094	X2 function choice	2: Multi speed 3 3.Exterior lift button 4. Exterior fall button	1	
F095	X3 function choice	5. Exterior crawl function 6.Normal close button 7. Exterior stop free	2	
F096	X4 function choice	8.counter 9.counetr to Zero 10.reversed inching	5	
F097	Relay output function	0:In status run; 1:Frequency output at the top 2:Fixed frequency arrived output	3	
F098	Y1 function choice	3:Accident output; 4:Lack of voltage 5:Counter to Zero;	0	
F099	Y1 function choice	6:Expiry 7:Expiry 8:In stop status 9~15:Preserve	0	

Protection function

Function code	Title function	Range of setting	Factory parameter	Note
F100	Prevention function for over Load when voltage reduce	110~150%rated voltage	130%	
F101	Prevention function for voltage over Load when speed fixed	110~150%rated voltage	130%	
F102	Prevention function for current over Load when speed up	80~180%rated current	130%	
F103	Prevention function for current over Load when speed fixed	80~180%rated current	130%	
F104	Fidden reverse roatae	0:Permit reverse 1:Firbidden reverse	1	
F105	Data protection	0:Permit modify data 1:Firbidden modify	0	
F106	Buff function	0:Expiry 1:validity	1	
F107	Frequency memory function	0:Memory open frequency 1:Present memory frequency	1	

Multi terminal

Function code	Title function	Range of setting	Factory parameter	Note
F108	Accident note 1	0:OC- 1 overload current when speed up 1: OC- 21 overload current when speed fall 2: OC- 3 overload current when speed normal 3: OU- 1 overload current when speed up		
F109	Accident note 2	4: OU- 2 overload current when speed fall 5: OC- 3 overload current when speed normal 6: LU voltage lack 7: OL overload 8: OH overheat 9: Ler output shirt circuit		
F110	Accident note 3	10: CPU system abnormality 11: PRG program checking error 12: EH exterior accident 13: 24Cn deposit error 14: Arg parameter error 15: No Fault 16: OFF time		
F111		0~10	0	
F112		0~60S	10S	

Other function

Function code	Title function	Range of setting	Factory parameter	Note
F113	Run time seeting	0~99999hour	0	
F114	Recover factory setting (Parameter initialization)	1:recover factory parameter Other: Expiry		
F115	Preserve			
F116	Preserve			

6.2 Function parameter specific instruction

Control Function

F000 Operation Frequency Setting Range: 0.0 ~ Top Frequency Factory Setting: 5.0HZ

Function Instruction: Such settings are used to set the current operating frequency of the Inverter. In the multi-speed or program operation time, it is also the setting source of the first sect speed frequency.

Note 1: When the frequency setting is controlled by panel key ▲▼, pressing the ▲▼ on the controlling panel can adjust operating frequency directly.

Note 2: Maximum of operation frequency is limited by Maximum Frequency (F004) and frequency to limit (F014).

F001 Choose operation control way Setting Range: 0~3 Factory Setting: 0

F001=0: Panel Control (positive rotating start,

F001=1: Outer terminal control (

F001=2: Outer terminal control (

F001=3: Outer terminal control (

Function Instruction: Such function is used to choose the controlling way of the start and stop of Inverter.

Note 1: When choosing panel control (F001=0), outer terminal control has no use. Use the  keys on operation panel to control of the start and stop of motor.

Note 2: When choosing panel control (F001=1),  panel has no use. Controlling terminal STF are connected with COM and RUN, STF and COM are broken and stop, STR and COM are connected and reverse, STR and COM are broken and stop.

Note 3: When choosing panel control (F001=2),  panel has no use. Controlling terminal STF and COM are connected and start, STF and COM are broken and stop, STR and COM are connected and reverse, STR and COM terminal are broken and RUN.

Note 4: When choosing panel control (F001=3),  panel has no use. X1~X4 multi-function terminals must have one terminal choosing outer NC pushbutton. (Check Details in F093~F096 function choose), consist of three-wire pushbutton control, otherwise this function has no use. Wiring way see below picture :

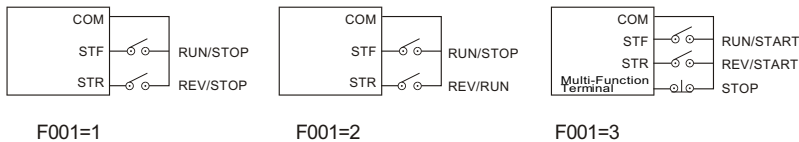

F002 Frequency Setting Way Choice Setting Range: 0~4 Factory Setting: 0

F002=0: Frequency is set by key ▲▼ on panel.

F002=1: Frequency is set by potentiometer on panel.

F002=2: Frequency is set by outer potentiometer or outer voltage DC 0~10V.

F002=3: Frequency is set by outer current DC 4~20mA.

F002=4: Frequency is set by out pushbutton up or down.

Function Instruction: Such function is used to choose operating frequency (when operating in multi-speed or by program, used as the operating frequency of one sector speed) settings or control source.

Note: When choosing frequency is set by outer pushbutton up or down (F002=4), X1~X4 multi-function terminals must have one choosing outer pushbutton up, one choosing outer pushbutton down (details are in function code F093~F096 function choice), otherwise this function will be useless, separately connect chosen terminal with COM terminal

F003 Machine Stop way choice Setting Range: 0~3 Factory Setting: 0

F003=0: Deceleration and Stop

F003=1: Free Stop

F003=2: Immediate DC Stop

F003=3: Out Free Stop

Function Instruction: Such function is used to choose the stop way of the Inverter.

Note 1: When choosing deceleration and stop (F003=0), motor decelerate to DC operation frequency F076, press F077 DC operation and F075 DC operation time stop.

Note 2: When choosing free stop (F003=1), after Inverter received stop demand, immediately cut off the power supply, motor freely stop.

Note 3: When choosing immediate DC stop (F003=2), after Inverter received stop demand, immediately press F077 DC operation stop and F075 DC operation time stop.

Note 4: When choosing out free stop (F003=3), X1~X4 multi-function terminal must have one terminal to choose out free stop (details are in function code F093~F096 function choice), otherwise this function will be useless, connection of chosen terminal and COM terminal can carry out out free stop.

V/F Curve Setting

F004 Highest Frequency Setting Range: Lowest Frequency~400.0HZ Factory Setting:50.HZ

Function Instruction: Such function is used to set the highest frequency of the Inverter's allowed output. All input frequency setting signal (0~5VDC,0~10V,4~20mA) top value correspond to this frequency range.

F005 Highest Voltage Setting Range: (380V) 320~480V Factory Setting: 380V

Function Instruction: Such function is used to set the highest output voltage of the transducer.

Note: This value must be or less than the rated voltage of the motor, and is normally set to be the rated voltage of the motor.

F006 Rated Frequency of Motor Setting Range: Middle Frequency~400.0HZ Factory Setting: 50.0HZ

Function Instruction: Such function is used to set the rated frequency of motor.

F007 Middle Frequency Setting Range: Lowest Frequency ~ Highest Frequency Factory Setting: 25.0HZ

Function Instruction: Such function is used to set the random middle frequency value of V/F curve.

Note: Middle frequency top value is limited by the highest frequency (F004), bottom value is limited by the lowest frequency (F009).

F008 Middle Voltage Setting Range: Lowest Voltage ~ 99% Rated Voltage Factory Setting: 50%

Function Instruction: Such function is used to set the random middle voltage value of V/F curve.

Note: Middle voltage top value is limited by the highest voltage (F005), bottom value is limited by the lowest voltage (F010).

F009 Lowest Frequency Setting Range: 0.0~10.0HZ Factory Settings: 0.0HZ

Function Instruction: Such function is used to set the lowest output frequency of the Inverter.

F010 Lowest Voltage Setting Range: 0 ~ 10% Rated Voltage Factory Settings: 1%

Function Instruction: Such function is used to set the lowest output voltage of the Inverter.

■ Below are V/F Curve Type ■ Generally Used V/F Curve Setting Value

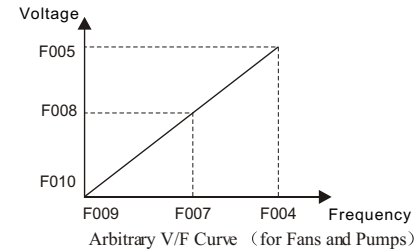

①Normal V/F Curve Settings

Function Code	Parameter Value
F004	50.0Hz
F005	380V
F007	25.0 Hz
F008	50%
F009	0.0 Hz
F010	1%

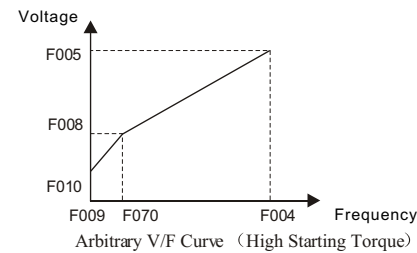

②High Starting Torque V/F Curve Setting Value

Function Code	Parameter Value
F004	50.0Hz
F005	380V
F007	3.0 Hz
F008	10%
F009	0.0 Hz
F010	3%

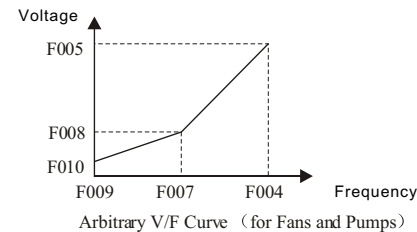

②Fan, Bump etc. V/F Curve Setting Value

Function Code	Parameter Value
F004	50.0Hz
F005	380V
F007	25.0 Hz
F008	25%
F009	0.0 Hz
F010	5%

Basic Function

F011	Analog input corresponding with highest frequency	Setting Range: 0~100%	Factory Setting: 100%
F012	Analog input corresponding with lowest frequency	Setting Range: 0~100%	Factory Setting: 1%

Function Instruction: When F011 and F012 functions are used to set analog input, the corresponding analog relation of the highest and lowest frequency

Note: When $F011 > F012$, the higher the analog input value is, the higher the rotating speed will be. When $F011 < F012$, the higher the analog input value is, the lower the rotating speed will be.

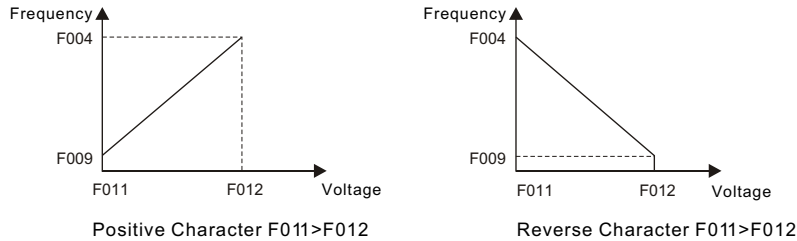

F013	Motor over-current protection current	Setting Range: 50~110%	Factory Setting: 100%
-------------	--	-------------------------------	------------------------------

Function Instruction: Such function is used to protect the motor over-current and factory set to be the rated current of the Inverter. When the power of the matched motor is lower than the power of the Inverter, set this value according to the rate of the actual used motor's rated current and the rated current of the Inverter. When the Inverter is used to protect several motors, it can not be used to protect motor. Now install thermal relay for each motor.

F014	Frequency Toplimit	Setting Range: frequency lowlimit ~ 400HZ	Factory Setting: 50.0HZ
-------------	---------------------------	--	--------------------------------

F-15	Frequency Lowlimit	Setting Range: 0.0HZ ~ frequency toplimit	Factory Setting: 1.0HZ
-------------	---------------------------	--	-------------------------------

Function Instruction: F014 and F015 function are used to set motor's highest output and lowest output frequency of the acceptable Inverter. If operating frequency setting is lower than the frequency toplimit or higher than the frequency toplimit, the Inverter only can work in the setting range of the frequency lowlimit and frequency toplimit.

Note 1: Frequency toplimit, bottom value is limited by frequency lowlimit (F015).
 Note 2: Frequency lowlimit top value is limited by frequency toplimit (F014).

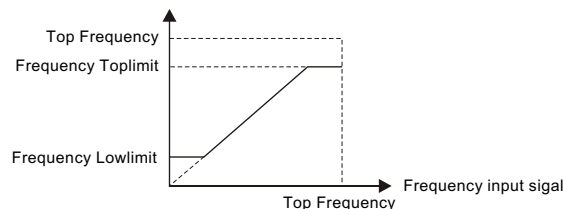

F016	Start Frequency	Setting Range: 0.0~10.0HZ	Factory Setting: 1.0HZ
-------------	------------------------	----------------------------------	-------------------------------

Function Instruction: Such function is used to set the start frequency of the Inverter.
 Note: If this value is set too much, it is easily to occur jump fault.

F017	Start time-delay time	Setting Range: 0.0~60.0S	Factory Setting: 0.5S
-------------	------------------------------	---------------------------------	------------------------------

Function Instruction: Such function is used to improve motor's start character, so as to ensure motor can be fully started in the set time.

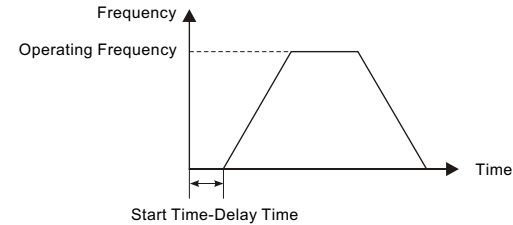

F018	Acceleration Time	Setting Range: 0.1~999.9S	Factory Setting: 10.0S
-------------	--------------------------	----------------------------------	-------------------------------

Function Instruction: Such function is used to set the time of output frequency rises from 0 to the top frequency of the Inverter. In the operation of multi-speed or by program, it is also the setting source of the acceleration time of the first sector.

Note: The factory setting of the Inverter deceleration time above 30KW is 20.0S

F019	Deceleration Time	Setting Range: 0.1~999.9S	Factory Setting: 10.0S
-------------	--------------------------	----------------------------------	-------------------------------

Function Instruction: Such function is used to set the time of output frequency fall from top frequency of the Inverter to 0. In the operation of multi-speed or by program, it is also the setting source of the deceleration time of the first sector.

Remark: The factory default setting of the deceleration time for the inverter (>30KW) is 20.0S.

F020	Choice of Acceleration, Deceleration Curve Method	Setting Range: 0~1	Factory Setting: 0
-------------	--	---------------------------	---------------------------

F020=0: operation in beeline way.

F020=1: operation in S Curve way, based on the operating frequency.

Function Instruction: Such function is used to choose Acceleration, Deceleration Curve Method is in beeline way or S Curve way. When operating in S Acceleration, Deceleration Curve, it has slowly acceleration and deceleration with no impact.

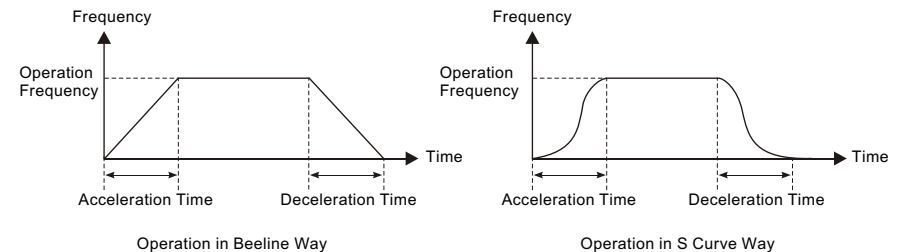

Crawl Function

When terminal has to lead out crawl function, X1~X4 multi-function terminal must have one of them choose out crawl (details are in function code F093~F096 function choice), otherwise this function is useless, and connection chosen terminal with COM terminal can realize out crawl function (factory setting X4 is crawl function).

When control panel's crawl function has to be effective, should set F021 to be 1. Leading out crawl function needs not to set F021.

F021 Choice of Crawl Function Setting Range: 0~1 Factory Setting: 0

F021=0: Crawl Function Ineffective.

F021=1: Crawl Function effective.

Function Instruction: Such function is used to choose whether the control panel's crawl function is effective or not.

F022 Crawl Frequency Setting Range: bottom frequency ~ top frequency Factory Setting: 5.0HZ

Function Instruction: Such function is used to set the output crawl frequency value of Inverter after Inverter received crawl instruction.

Note: Crawl Frequency top value is limited by top frequency (F004), bottom value is limited by lowest frequency (F009).

F023 Crawl Acceleration Time Setting Range: 0.1~999.9S Factory Setting: .50S

Function Instruction: The time of output frequency rising from 0 to crawl frequency, after the Inverter received crawl start instruction.

F024 Crawl Deceleration Time Setting Range: 0.1~999.9S Factory Setting: 5.0S

Function Instruction: The time of output frequency falling from crawl frequency to 0, after the Inverter received crawl stop instruction.

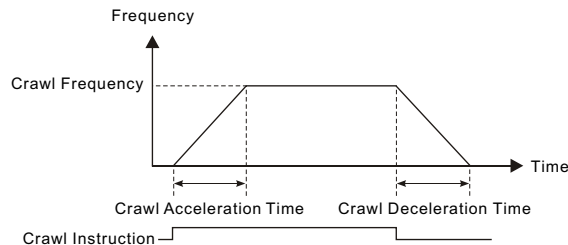

Multi-Speed Operation

In multi-speed operation, F000 is the operation frequency of the first sector, F018 is the acceleration time of the first sector, F019 engaged in operation as the deceleration time of the first sector.

In multi-speed operation, reverse rotation is controlled by corresponding operation direction of the operation program (F049, F051, F053, F055, F057, F059, F061, F063).

In multi-speed operation, X1~X4 multi-function terminal must have two or three of them (below 4-sector speed, can use two terminal separately and choose multi-speed 1,2) separately choose 1,2,3 (details in function code F093~F096 function choice), otherwise this function will be useless, the connection and interruption of chosen terminal with COM terminal can carry out at most 8-sector speed operation function.

The election of multi-sector speed is determined by the interruption and connection of multi-sector speed X1, multi-sector speed X2, multi-sector speed X3 and COM terminal. Details are in below table:

Multi-Sector Speed 1	Multi-Sector Speed 2	Multi-Sector Speed 3	Multi-Speed Choice
OFF	OFF	OFF	First Sector Operation Frequency set by F000
ON	OFF	OFF	Second Sector Operation Frequency set by F025
OFF	ON	OFF	Third Sector Operation Frequency set by F028
ON	ON	OFF	Four Sector Operation Frequency set by F031
OFF	OFF	ON	Five Sector Operation Frequency set by F034
ON	OFF	ON	Six Sector Operation Frequency set by F037
OFF	ON	ON	Seven Sector Operation Frequency set by F040
ON	ON	ON	Eight Sector Operation Frequency set by F043

Note: Connection with COM terminal is ON. Interruption with COM terminal is OFF.

■ Multi-Step Speed Control as below:

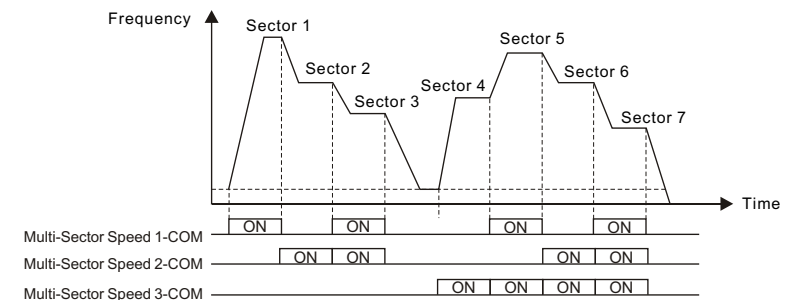

F025 Sector 2 Speed Frequency	Setting Range: Bottom Frequency ~Top Frequency	Factory Setting:5.0HZ
F026 Sector 2 Speed Acceleration Time	Setting Range:0.0~999.9S	Factory Setting:10.0S
F027 Sector 2 Speed Deceleration Time	Setting Range:0.0~999.9S	Factory Setting:10.0S

Function Instruction: These functions are used to set the frequency, acceleration time, deceleration time of the sector 2 speed, when the Inverter is operated in multi-speed or by program.

F028 Sector3 Speed Frequency	Setting Range: Bottom Frequency ~Top Frequency	Factory Setting:10.0HZ
F029 Sector 3 Speed Acceleration Time	Setting Range:0.0~999.9S	Factory Setting:10.0S
F030 Sector 3 Speed Deceleration Time	Setting Range:0.0~999.9S	Factory Setting:10.0S

Function Instruction: These functions are used to set the frequency, acceleration time, deceleration time of the sector 3 speed, when the Inverter is operated in multi-speed or by program.

F031 Sector 4 Speed Frequency	Setting Range: Bottom Frequency ~Top Frequency	Factory Setting:20.0HZ
F032 Sector 4 Speed Acceleration Time	Setting Range:0.0~999.9S	Factory Setting:10.0S
F033 Sector 4 Speed Deceleration Time	Setting Range:0.0~999.9S	Factory Setting:10.0S

Function Instruction: These functions are used to set the frequency, acceleration time, deceleration time of the sector 4 speed, when the Inverter is operated in multi-speed or by program.

F034 Sector 5 Speed Frequency	Setting Range: Bottom Frequency ~Top Frequency	Factory Setting:30.0HZ
F035 Sector 5 Speed Acceleration Time	Setting Range:0.0~999.9S	Factory Setting:10.0S
F036 Sector 5 Speed Deceleration Time	Setting Range:0.0~999.9S	Factory Setting:10.0S

Function Instruction: These functions are used to set the frequency, acceleration time, deceleration time of the sector 5 speed, when the Inverter is operated in multi-speed or by program.

F037 Sector 6 Speed Frequency	Setting Range: Bottom Frequency ~Top Frequency	Factory Setting:40.0HZ
F038 Sector 6 Speed Acceleration Time	Setting Range:0.0~999.9S	Factory Setting:10.0S
F039 Sector 6 Speed Deceleration Time	Setting Range:0.0~999.9S	Factory Setting:10.0S

Function Instruction: These functions are used to set the frequency, acceleration time, deceleration time of the sector 6 speed, when the Inverter is operated in multi-speed or by program.

F040 Sector 7 Speed Frequency	Setting Range: Bottom Frequency ~Top Frequency	Factory Setting:50.0HZ
F041 Sector 7 Speed Acceleration Time	Setting Range:0.0~999.9S	Factory Setting:10.0S
F042 Sector 7 Speed Deceleration Time	Setting Range:0.0~999.9S	Factory Setting:10.0S

Function Instruction: These functions are used to set the frequency, acceleration time, deceleration time of the sector 7 speed, when the Inverter is operated in multi-speed or by program.

F043 Sector 8 Speed Frequency	Setting Range: Bottom Frequency ~Top Frequency	Factory Setting:50.0HZ
F044 Sector 8 Speed Acceleration Time	Setting Range:0.0~999.9S	Factory Setting:10.0S
F045 Sector 8 Speed Deceleration Time	Setting Range:0.0~999.9S	Factory Setting:10.0S

Function Instruction: These functions are used to set the frequency, acceleration time, deceleration time of the sector 8 speed, when the Inverter is operated in multi-speed or by program.

Program Operation

In program operation, operation frequency, acceleration time and deceleration time is set by multi-sector speed function F025~F045, F000 participate operation as the frequency of program operation 1 and acceleration/deceleration time of F018, F019.

F046 Program Operation Mode	Setting Range: 0~3	Factory Setting: 0
------------------------------------	---------------------------	---------------------------

F046=0: invalid

F046=1: monocyte operation and stop

F046=2: continuous cycle operation

F046=3: monocyte operation and operation in last frequency.

Note 1: When choosing monocyte operation and stop (F046=1), finish one cycle and stop operation according to the set sectors.

Note 2: When choosing continuous cycle operation (F046=2), continuously cycle operation.

Note 3: When choosing monocyte operation and operation in last frequency (F046=3), finish one cycle and operate in last frequency according to the set sectors.

F047 Program Operation Time coefficient	Setting Range: 0~100	Factory Setting: 1
--	-----------------------------	---------------------------

Function Instruction: Such function is used to set operation time coefficient of the program operation, multiplying operation set time to be actual operation time.

For example: Set this coefficient to be 10, set program operation 1 time to be 1.0S, then the actual operation time is 10.0S.

F048 Program Operation 1 Time	Setting Range: 0.0~999.9	Factory Setting: 0.0
--------------------------------------	---------------------------------	-----------------------------

F050 Program Operation 2 Time	Setting Range: 0.0~999.9	Factory Setting: 0.0
--------------------------------------	---------------------------------	-----------------------------

F052 Program Operation 3 Time	Setting Range: 0.0~999.9	Factory Setting: 0.0
--------------------------------------	---------------------------------	-----------------------------

F054 Program Operation 4 Time	Setting Range: 0.0~999.9	Factory Setting: 0.0
--------------------------------------	---------------------------------	-----------------------------

F056 Program Operation 5 Time	Setting Range: 0.0~999.9	Factory Setting: 0.0
--------------------------------------	---------------------------------	-----------------------------

F058 Program Operation 6 Time	Setting Range: 0.0~999.9	Factory Setting: 0.0
--------------------------------------	---------------------------------	-----------------------------

F060 Program Operation 7 Time	Setting Range: 0.0~999.9	Factory Setting: 0.0
--------------------------------------	---------------------------------	-----------------------------

F062 Program Operation 8 Time	Setting Range: 0.0~999.9	Factory Setting: 0.0
--------------------------------------	---------------------------------	-----------------------------

Function Instruction: Above functions is used to set the operation time value of the program operation sector 1~8, when set to be 0.0, it does not participate the program operation.

F048 Program Operation 1 Direction	Setting Range: 0.0~999.9	Factory Setting: 0.0
---	---------------------------------	-----------------------------

F050 Program Operation 2 Direction	Setting Range: 0.0~999.9	Factory Setting: 0.0
---	---------------------------------	-----------------------------

F052 Program Operation 3 Direction	Setting Range: 0.0~999.9	Factory Setting: 0.0
---	---------------------------------	-----------------------------

F054 Program Operation 4 Direction	Setting Range: 0.0~999.9	Factory Setting: 0.0
---	---------------------------------	-----------------------------

F056 Program Operation 5 Direction	Setting Range: 0.0~999.9	Factory Setting: 0.0
---	---------------------------------	-----------------------------

F058 Program Operation 6 Direction	Setting Range: 0.0~999.9	Factory Setting: 0.0
---	---------------------------------	-----------------------------

F060 Program Operation 7 Direction	Setting Range: 0.0~999.9	Factory Setting: 0.0
---	---------------------------------	-----------------------------

F062 Program Operation 8 Direction	Setting Range: 0.0~999.9	Factory Setting: 0.0
---	---------------------------------	-----------------------------

Function Instruction: Above functions is used to set the direction of positive and reverse rotation of the program operation sector 1~8, 0: positive rotation and 1: reverse rotation.

PID Function

PID control is through detecting the measured out feedback value of the controlled object, comparing with the set target value, then adjust and control the deviation to be 0.

Functions of PID controller's three parts: rate P, integral I, differential D are as below:

1. Rate P Control: Adjustment value is output according to error and proportion, When only controlled by rate P, the error will not be 0.
2. Integral I Control: Adjustment value is output according to error's integral, when error is 0, the output is constant.
3. Differential D Control: Adjustment value is output according to error's differential, when error changes suddenly, it can be easily controlled.
4. PID Control: Assemble three advantages and achieve the best control performance.

Adjustment way of PID control:

Set the Inverter's PID closed loop control way to be valid, detecting system output through the feedback signal, adjust the parameter of PID controller according to output wave. Normally adjust according to below rules:

When output is not concussed, increase rate increment P.

When output is not concussed, decrease integral time constant I.

When output is not concussed, increase differential time constant D.

In actual adjustment, adjust PID parameter according to below steps:

Suppress output overshoot: decrease differential time constant D, increase integral time constant I.

Note: When PID operating, the positive, reverse relation of input value and rotating speed, is determined by the set value of F011 and F012.

F064 PID Mode Choice Setting Range: 0~1 Factory Setting: 0

F064=0: PID Function is not valid.

F064=1: PID Function is valid.

F065 PID Target Value Setting Way Choice Setting Range: 0~4 Factory Setting: 0

F065=0: PID Target Value is set by panel ▲▼.

F065=1: PID Target Value is set by panel potentiometer.

F065=2: PID Target Value is set by outer potentiometer or outer voltage DC 0~10V.

F065=3: PID Target Value is set by outer current DC 4~20mA.

F065=4: PID Target Value is set by outer pushbutton up or down.

Function Instruction: Such function is used to choose the target value source when PID is operated.

F066 PID FeedbackWay Choice Setting Range: 0~1 Factory Setting: 1

F066=0: Outer Voltage.

F066=1: Outer Current.

Function Instruction: Such function is used to choose the source of PID feedback value.

F067 Maximum Target Value Setting Range: 0~9999 Factory Setting: 1000

Function Instruction: Such function is used to set the maximum target value when PID is operated.

F068 Relevant Feedback Value of Maximum Target Value Setting Range: 0~100% Factory Setting: 100%

Function Instruction: Such function is used to set the Relevant Feedback Value of Maximum Target Value when PID is operated.

F069 Minimum Target Value Setting Range: 0~9999 Factory Setting: 0

Function Instruction: Such function is used to set the minimum target value when PID is operated.

F070 Relevant Feedback Value of Minimum Target Value Setting Range: 0~100% Factory Setting: 0%

Function Instruction: Such function is used to set the Relevant Feedback Value of minimum Target Value when PID is operated.

F071 Gain Rate Setting Range: 0.00~99.99 Factory Setting: 1.00

Function Instruction: When gain rate takes large value, its response is quick, but if too large, it always generates concussion. If takes small value, its response is slow.

F072 Integral Time Setting Range: 0.00~99.9S Factory Setting: 1.0S

Function Instruction: When integral time takes large value, its response is slow and its outer control ability becomes worse. When integral time takes small value, its response is quick but if too small it always generates concussion.

F073 Differential Time Setting Range: 0.00~99.9S Factory Setting: 1.0S

Function Instruction: When differential time takes large value, its response is quick, but if too large, it always generates concussion. If takes small value, its response is slow.

F074 Feedback Value Smoothing Coefficient Setting Range: 0~200% Factory Setting: 100%

Function Instruction: When feedback signal superimposed and have noise, it will effect feedback precision. In this situation, please adjust feedback smoothing coefficient. Note: If set the smoothing coefficient too large, it will cause the delay of control response, make worse of control performance.

AC brake function

F075 DC Braking Time Setting Range: 0.0~25.0S Factory Setting: 0.3S

Function Instruction: Such function is used to set the needed time from DC braking start to motor stop, when F003 is set to 0 or 2.

F076 DC Braking Start Frequency Setting Range: 0.0~50.0HZ Factory Setting: 3.0HZ

Function Instruction: Such function is used to set when F003=0, after motor freely decelerate to the frequency value set by this function, press F077 DC braking torque and F075 DC braking operation time to brake stop.

F077 DC Operation Torque Setting Range: 0~30% Factory Setting: 4%

Function Instruction: Such function is used to set the braking torque after in DC braking to ensure to make the motor fully stop in braking time.

Note: If DC braking torque is set to high, the Inverter will easily stop. Increase it slowly when setting the braking torque.

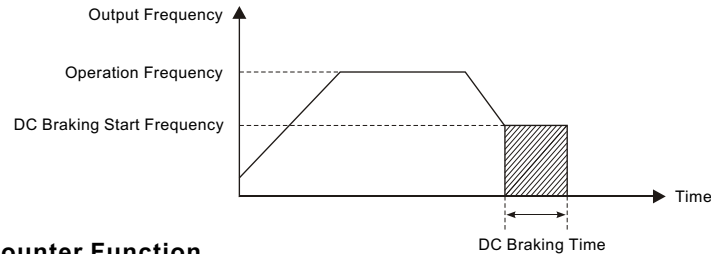

Counter Function

F078 Count Mode Setting Range: 0~2 Factory Setting: 0

F078=0: Count function is ineffective.

F078=1: Count function is effective, upward count mode.

F078=2: Count function is effective, downward count mode.

Function instruction: When choosing count function is effective (F078=1 or F078=2), count pulse is input by multi-function (X1~X4), X1~X4 multi-function terminal must have one of which to choose pulse input function (details are in function code F093~F096 function choice), otherwise this function will be ineffective.

F079 Count Value Setting Range: 0~9999 Factory Setting: 1

Function Instruction: Such function is used to set the counter's default value, if choosing upward count way, when count value is equal to the default value, it will stop count and execute count to treatment action. If choosing downward count way, when count value is 1, it will stop count and execute count to treatment action.

F080 Count Unit Setting Range: 0~9999 Factory Setting: 1

Function Instruction: Such function is used to set the unit value of each count pulse and could count relevant object.

F081 Count to Treatment Setting Range: 0~3 Factory Setting: 0

F081=0: Stop count and close output.

F081=1: Stop count and continue output.

F081=2: Restart count and stop output.

F081=3: Restart count and continue output.

Function Instruction: Such function is used to choose the action when the counter count to time.

Note: Counter Zero Clearing Operation please press .

Special Function

F082 AVR Function Setting Range: 0~1 Factory Setting: 1

F082=0: Ineffective.

F082=1: Automatically stabilized the voltage.

Function Instruction: Such function is used to set the Inverter's voltage-stabilization function.

Note: When F082=1 and input voltage > = output voltage set value, AVR function will ensure output voltage constant. When F082=1, input voltage < output voltage set value, output voltage =input voltage

F083 Torque Hoisting Setting Range: 0~30% Factory Setting: 4%

Function Instruction: Such function is used to improve the torque character when the Inverter is operated in low frequency, through adjusting the output voltage of the Inverter, it can improve the output moment in the operation in low frequency. If the set value is to large, the Inverter will come out jump fault.

Note: When the torque hoisting is set to 0, the torque hoisting will be ineffective, the Inverter will be operated according to the set value of V/F curve, otherwise V/F curve set will be ineffective.

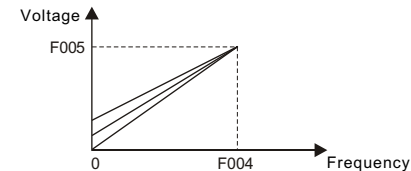

F084 Slip Compensation Setting Range: 0.0~5.0HZ Factory Setting: 0.0HZ

Function Instruction: Such function is used to set the rated compensation frequency value of the slip compensation. When load of motor increases, its rotational speed will be down. The aim of slip compensation is to adjust output frequency to compensate the reduced rotational speed, to make motor reach synchronizing speed more, when the set value is 0.0, the slip compensation will not act.

F085 Carrier Wave Frequency Setting Range: 1~12KHZ Factory Setting: 5

Function Instruction: The higher the carrier wave frequency is, the more perfect the current waveform will be, the lower the motor noise will be, the smaller the torque on low frequency will be, the larger electromagnetism disturbance will be, the larger main element loss will be, the larger Inverter fever will be, the larger leakage current will be, the lower the efficiency will be. The lower carrier wave frequency is, it will be reverse.

Carrier Wave Frequency abridged general view is as below:

Carrier Wave Frequency	Electromagnetism Noise	Disturbance, Leakage Current	Fever Value
1.0KHz	Large	Small	Small
↑ ↓	↑ ↓	↑ ↓	↑ ↓
10.0KHz	Small	Large	Large

Note: Carrier wave of Inverter above 30KW is factory set to 3.

F086 Instant Power-Off Restart Function Setting Range:0~2 Factory Setting: 0

F086=0: Ineffective

F086=1: Continuous Operation after power comes back.

F086=2: Restart when power comes back.

Function Instruction: Such function is used to set the motor's operation way when instant power-off and power back.

Note 1: When choosing ineffective (F086=0), when instant power-off and power back, the motor will not start and will alarm for under voltage.

Note 2: When choosing Continuous Operation after power comes back (F086=1), when instant power-off and power back, the motor will operate according to the power-off state, it is applicant to high inertance load.

Note 3: When choosing Restart when power comes back (F086=2), when instant power-off and power back, the motor will restart according to the power-off state, it is applicant to normal load.

Note 4: When the Inverter is set the function of Instant Power-Off Restart Function, please set Danger sign or else in conspicuous place in front of the machine device, in order not to cause accident for the machine will suddenly start when the power comes back.

F087 Frequency Reach Setting Setting Range: 0.0~400.0HZ Factory Setting: 0.0HZ

Function Instruction: Such function is used to set the reach signal point of the operation frequency, through output signal by multi-function output port (Y1,Y2). Y1,Y2 multi-function output terminal have one of which to choose frequency reach setting (details in function code F098,F099 function choice), otherwise this function will be ineffective. When frequency reach to the setting, there will be output of DC 24V 50mA between multi-function terminal and COM terminal.

F088 Analogue Input Gain Setting Range: 0~200% Factory Setting: 100%

Function Instruction: when frequency input is analogue signal input, ratio of the maximum output frequency value with relevant frequency set signal value is frequency gain (in another word, when input signal is not more than 10V/20mA, through adjusting analogue input gain, it can also reach 10V or 20mA frequency). It can also be used to the compensation of the frequency setting.

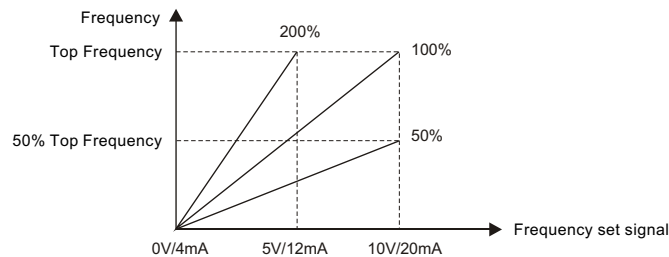
**F089 Analogy Output Choice Setting Range: 0~2 Factory Setting: 0**

F089=0: Analogy Frequency Count.

F089=1: Analogy Current Count.

F089=2: Analogy Voltage Count.

Function Instruction: Such function is used to remote monitoring of the Inverter output frequency, output voltage, or output current, through connecting a DC analogue pointer type frequency count, voltage count or current count between AFM+ and COM terminals.

F090 Analogy Output Gain Setting Range: 50~150% Factory Setting: 100%

Function Instruction: Such function is used to adjust (F089) the error of analogy signal output value and actual value.

F091 Start Display Choice Setting Range: 0~8 Factory Setting: 0

F091=0: Display output frequency.

F091=1: Display output current.

F091=2: Display output voltage.

F091=3: Display DC bus bar voltage.

F091=4: Display motor rotation speed.

F091=5: Display PID target value.

F091=6: Display PID feedback value.

F091=7: Display counter value.

F091=8: Display module temperature.

Function Instruction: Such function is used to set the display content when Inverter starts.

F092 Speed Coefficient Setting Range: 0.00~99.99 Factory Setting: 30.00

Function Instruction: Such function is used to the ratio of the speed display value with actual frequency, then make the speed display speed coincident with the actual motor rotation speed.

Speed display value = output frequency X speed display coefficient

For example: Output frequency: 50.0HZ motor's speed is 1500 round/minute.
Then set value = motor speed 1500 / output frequency 50 = 30.

Multi-Function Terminal

F093 X1 Multi-Function Input Terminal Function Choice Setting Range: 0~9 Factory Setting: 0
F094 X2 Multi-Function Input Terminal Function Choice Setting Range: 0~9 Factory Setting: 1
F095 X3 Multi-Function Input Terminal Function Choice Setting Range: 0~9 Factory Setting: 2
F096 X4 Multi-Function Input Terminal Function Choice Setting Range: 0~9 Factory Setting: 5

F093 ~ F096 multi-function input terminal function choice content in below table:

Parameter Value	Function Content
0	Multi-function speed 1
1	Multi-function speed 2
2	Multi-function speed 3
3	Outer pushbutton up
4	Outer pushbutton down
5	Outer crawl function
6	Outer NC stop pushbutton
7	Outer free stop
8	Counter pulse input
9	Counter zero clearing
10	Reversed inching

F097 Relay Output Terminal Function Choice Setting Range: 0~15 Factory Setting: 3
F097 Y1 Multi-Function Output Terminal Function Choice Setting Range: 0~15 Factory Setting: 0
F097 Y2 Multi-Function Output Terminal Function Choice Setting Range: 0~15 Factory Setting: 0

• F097~F099 multi-function output terminal function choice content is as below table:

Parameter Value	Function Content
0	In operation
1	Frequency reached to Top
2	Set frequency arrived
3	Fault output
4	Under voltage
5	Count arrives
6.7	Ineffective
8	In stop
9~15	Conservation

Protection Function

F100 Deceleration Over-voltage Stall-prevention Function Setting Setting Range: 110~150% Factory Setting: 130%
--

Function Instruction: In deceleration operation of Inverter, when output voltage exceeded this set value, Inverter would stop deceleration and continue deceleration after current restored to be below the set value.

F101 Constant-Velocity Over-voltage Stall-prevention Function Setting Setting Range: 110~150% Factory Setting: 130%

Function Instruction: In operation of Inverter, due to many reasons, output voltage may exceed this set value, Inverter would reduce output frequency and continue recovery to operation frequency after voltage restored to be normal.

F102 Acceleration Over-current Stall-prevention Function Setting Setting Range: 80~180% Factory Setting: 130%

Function Instruction: In acceleration of Inverter, when output current exceeded this set value, Inverter would stop acceleration and continue acceleration after current restored to be below the set value.

F103 Constant-Velocity Over-current Stall-prevention Function Setting Setting Range: 80~180% Factory Setting: 130%
--

Function Instruction: In operation of Inverter, due to mechanical character, mechanical impact or overload, Inverter will overload and occur jump fault, when Inverter rotation current exceed set value, Inverter will reduce output frequency and continue recovery to operation frequency after voltage restored to be normal.

F104 Reverse Rotation Forbidden Function Setting Range: 0~1 Factory Setting: 1

F014=0: Allow reverse rotation.
F014=1: Forbid reverse rotation

Function Instruction: Such function is used to choose whether motor has forbidden the reverse rotation.

F105 Parameter Lock Setting Range: 0~1 Factory Setting: 0
--

F015=0: Ineffective.
F015=1: Effective.

Function Instruction: When F015=1, all parameter modification will be ineffective (except operation frequency F000), data will not be conserved.

F106 Absorption of Vibration Function Setting Range: 0~1 Factory Setting: 1
--

F016=0: Ineffective.
F016=1: Effective.

Function Instruction: Such function is used to choose motor vibration function.
Note: When input voltage is 200V, please do not choose such function to be effective.

F107 Frequency Memory Function Setting Range: 0~1 Factory Setting: 1

F017=0: Memorize start frequency.
F017=1: Memorize current frequency.

Function Instruction: Such function is used to set whether the randomly adjusted operation frequency after the power-off will be memorized and save.

Fault Function

F108	Fault Record 1	Display Content: 0~15
F109	Fault Record 2	Display Content: 0~15
F110	Fault Record 3	Display Content: 0~15

- Fault record content in below table:

Parameter Value	Fault Code	Fault Content
0	OC-1	Over-current in acceleration
1	OC-2	Over-current in deceleration
2	OC-3	Over-current in constant-velocity
3	OU-1	Over-voltage in acceleration
4	OU-2	Over-voltage in deceleration
5	OU-3	Over-voltage in constant-velocity
6	LU	Under Voltage
7	OL	Overload
8	OH	Overheat
9	Ler	Output short circuit
10	CPU	System abnormal
11	PRG	Program code checked wrong
12	EH	Outer fault
13	24Cn	Memorizer fault
14	Arg	Parameter fault
		No fault
15	OFF	Operation time arrives

F111 Fault Restart Times Setting Range: 0~10 Factory Setting: 0

Function Instruction: After fault, Inverter will restore operation, totally 10 times are allowed to restore operation after fault of every power-on.

F112 Fault Restart Wait Time Setting Range: 0~60S Factory Setting: 10S

Function Instruction: When fault restart, delay the time set by this function and carry out restart operation.

Other function

F113 Operation Time Setting Range: 0~9999hour

Function Instruction: Such function is used to check whether Inverter's actual operation time.

F114 Restore Factory Setting (initialization) Setting Range: 0~1 Factory Setting: 0

F114=1: Restore factory setting.

Other: Ineffective.

Function Instruction: When set to be 1, all parameter will be restored to the factory settings, if set to other value, such function will be ineffective.

F115 Reservation

F116 Reservation

Article7

Fault Diagnosis and Treatment

7.1 Fault Display and Reason

7.2 Main Fault Diagnosis and Treatment

7.2.1 Under Voltage 60

7.2.2 Over-Voltage 61

7.2.3 Over-Current 62

7.2.4 Overload 63

7.2.5 Output Short Circuit or Motor Earth Leakage 63

7.2.6 Radiator Overheat 63

7.3 Motor Abnormality and Treatment 64

7.3.1 Motor not start 64

7.3.2 Motor can operate but can not adjust speed 65

7.3.3 Motor abnormally heats 65

This series Inverter has over-current, over-voltage, overheat, overload and else multi-kind protection function, once fault happened, Inverter will alarm and stop output, motor stop operation and LED monitor displays relevant fault code. This chapter will give out some common fault display code and treatment way

7.1 Malfunction display and reason

Malfunction display and reason, solution shows below:

Malfunction code	Malfunction name	Possible reason for malfunction	Solution
OC-1	Over-current when accelerating	Short circuit between motor connected terminal phases Load change suddenly Accelerate time too short	Check output circuit and load Decrease circuit load capacity Reset decelerate time
OC-2	Over-current when decelerating		
OC-3	Over-current when constant-speed	Motor jammed-turn Inverter inner malfunction	Examine motor Contact with our company
OU-1	Over-voltage when accelerating	Input voltage abnormal Decelerate time to short	Check input power Reset decelerate time
OU-2	Over-voltage when decelerating	Unsuitable braking component	
OU-3	Over-voltage when constant-speed	Load inertia moment too big	Re-choose braking component Decrease load inertia moment
LU	Under-voltage	Input voltage abnormal Big capacity load operate in the same line Inverter inner malfunction	Check input power Decrease circuit load capacity Contact with our company
OL	Over-load	Over load Unsuitable set-up parameter of electronic over-load protection	Decrease load or increase capacity Re-set electronic over-load parameter
OH	Over-heat	Environment temperate too high Cool fan damaged	Reduce environment temperate Replace fan
Ler	Output short-circuit	Output side short circuit Inverter inner malfunction	Check output circuit Contact with our company
CPU	System abnormal	Mal-operated when interfered Out-put protection circuit mal-operated	Eliminate interference
PRG	Program code check mistake	Inverter inner malfunction	Contact with our company
EH	External malfunction	External-controlled malfunction Terminals closed	Break external-controlled terminals
24Cn	Memorize mistake	Inverter inner malfunction	Contact with our company
Arg	Parameter mistake	Inverter inner malfunction	Contact with our company
OFF	Running time over	Setting running time over	Contact with our company

Notice: If the Inverter malfunction protection trip, eliminate the malfunction, press



or reset to input by external-controlled terminals to relieve the trip state.

7.2 Diagnose and treatment of main malfunction

7.2.1 Under-voltage

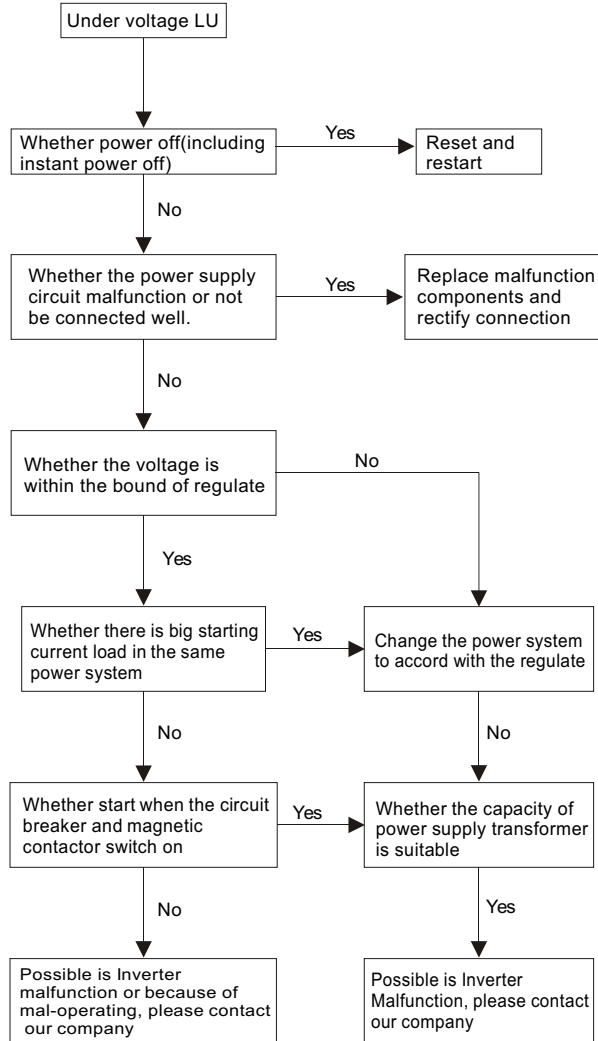

7.2.2 Over-voltage

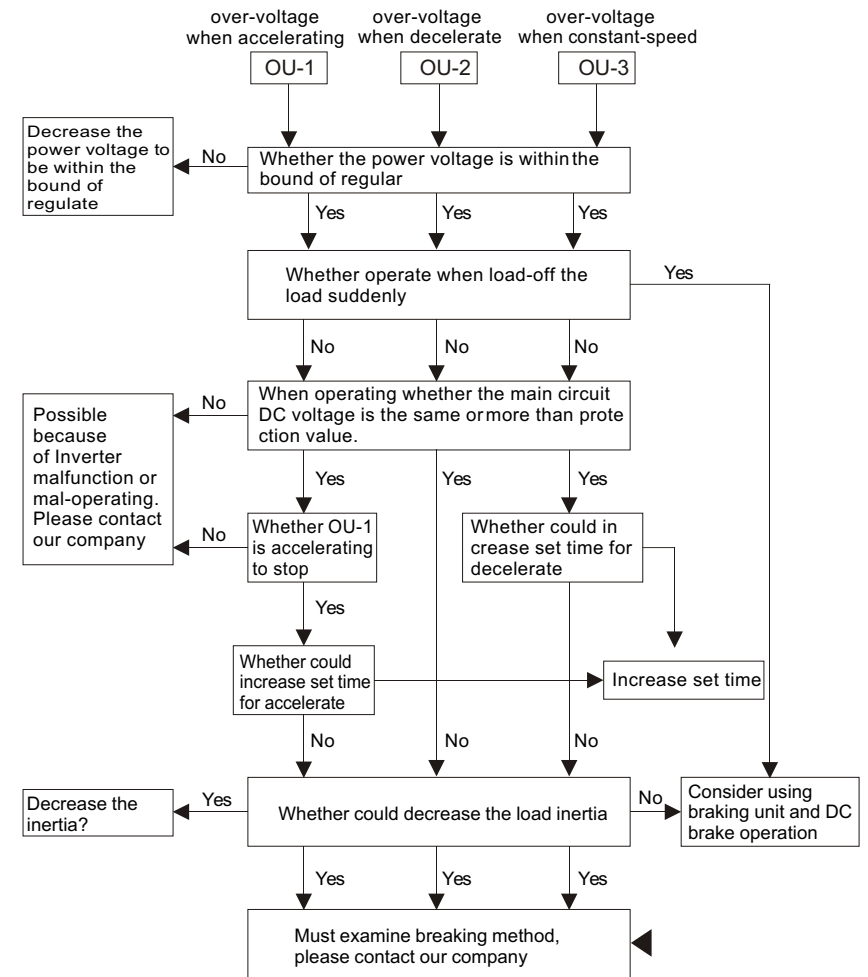

7.2.3 over-current

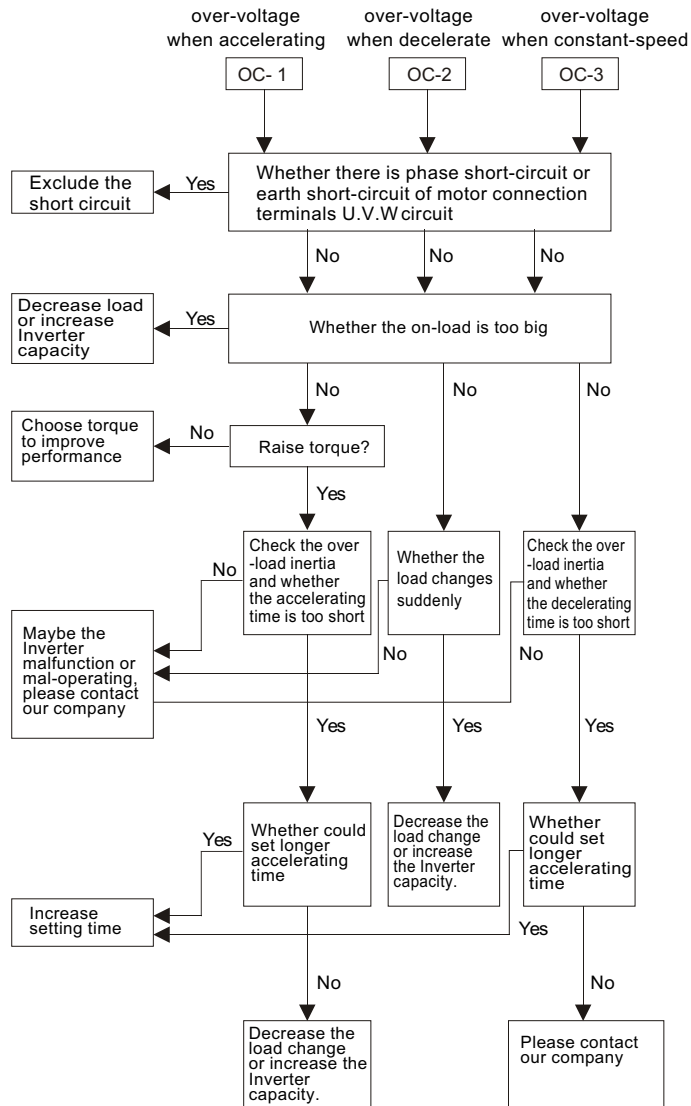

7.2.4 over-load

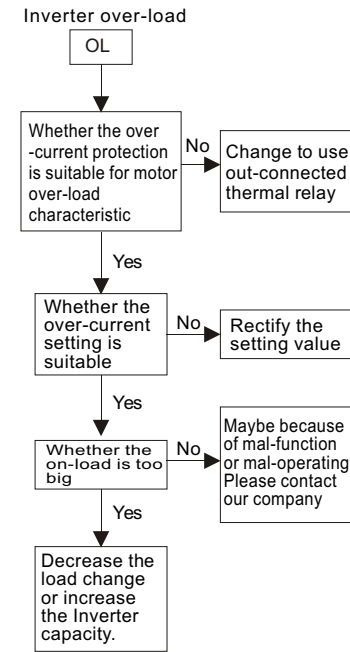

7.2.6 Radiator too heat

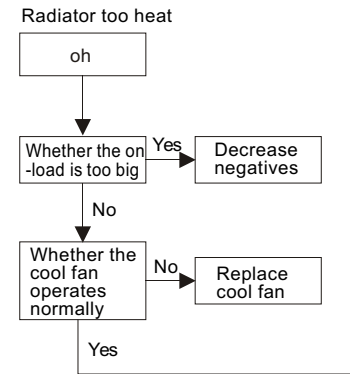

7.2.5 output short-circuit or motor electric-leak

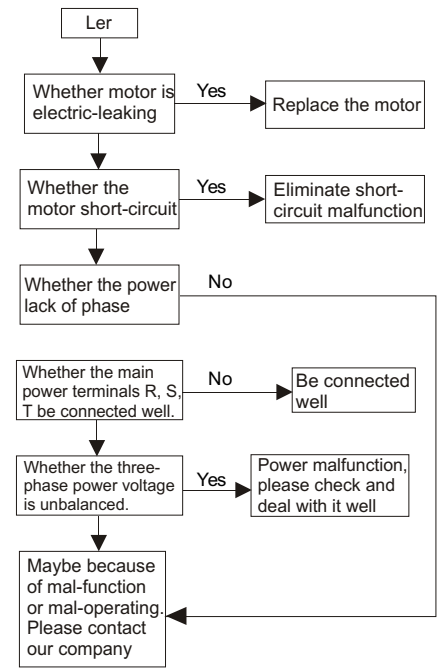

7.3 Motor malfunction and insulation

7.3.1 Motor not starting

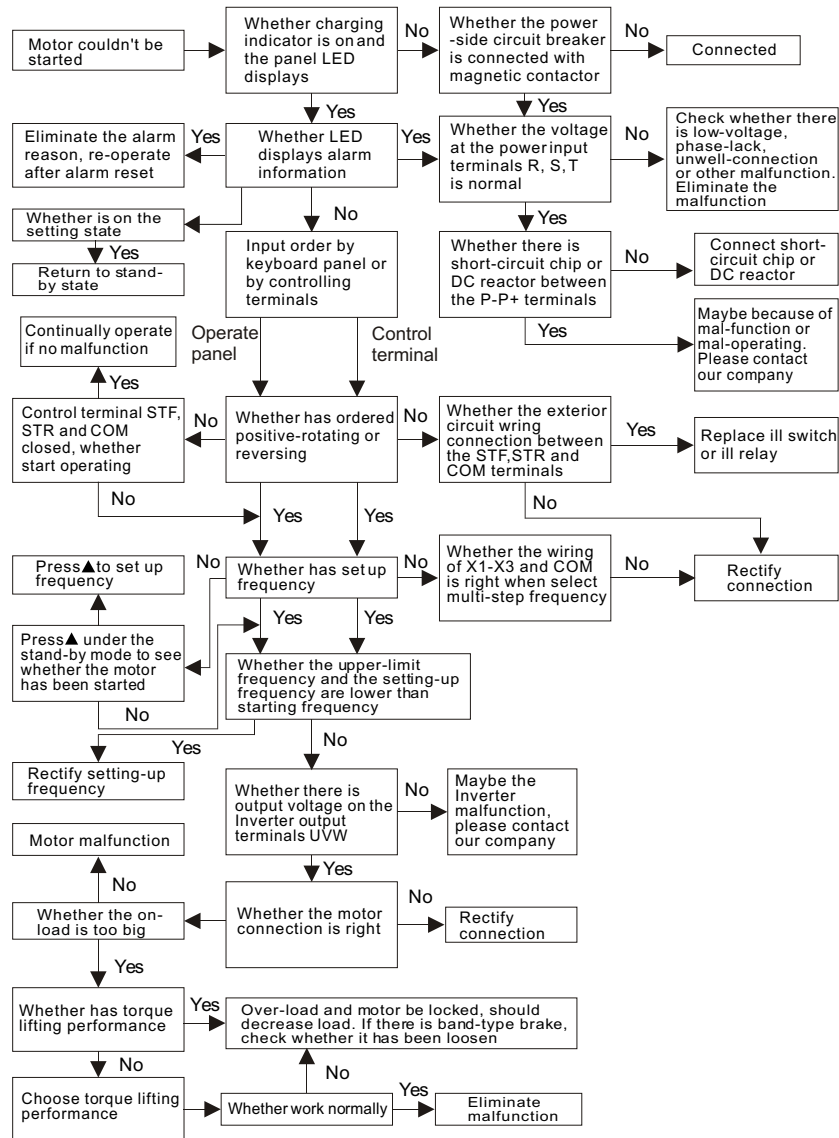

7.3.2 Motor could operate but couldn't change speed

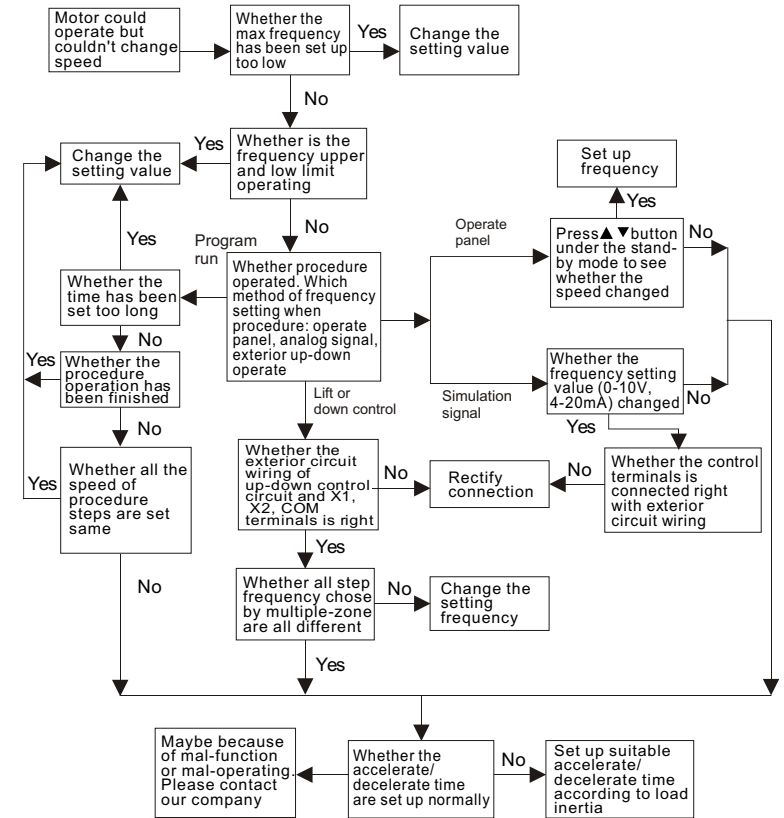

7.3.3 Motor heat abnormally

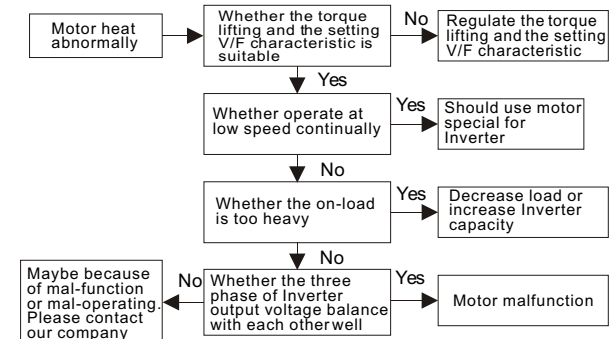

Article8

Examination and Maintenance

8.1 Examination and Maintenance 67

8.1.1 safety care

8.1.2 daily examination 67

8.1.3 regular examination 67

8.1.4 measure of Inverter 68

8.1.5 replace of components 68

8.2 Transportation and Deposit 68

8.2.1 transportation of Inverter 68

8.2.2 storage of Inverter 68

This chapter will introduce you the daily examination and the regular maintenance. Factors of using environment and aging of inner component may induce the malfunction. So the Inverter should be daily examination and regular maintenance during the deposit and the use.

8.1 Examination and Maintenance

8.1.1 safety care

- ⚠ Danger: before examination and maintenance, should cut off the power at first.
- ⚠ Danger: after cutting off the power, don't open case for examination and maintenance within five minutes, because there is still residual high voltage in the Inverter.
- ⚠ Danger: don't examine or maintain if is unprofessional, lest damage the Inverter.
- ⚠ Attention: the electronic accessories in the Inverter is sensitive to static, don't touch circuit board by hand before static-proof measure, lest the static induction damage the chip on the circuit board.
- ⚠ Attention: please don't leave tool and other eyewinker in the Inverter, or else it'll bring malfunction.
- ⚠ Attention: please close the cover and screwed tightly after the examination.

8.1.2 Daily Examination

Examination Item	Examination Content
Electric motor	Examine the motor if there is unusual voice or quiver
Fan	Examine the cool fan if it works normally
Load	Examine the load of the Inverter if the same as usual
Display	Examine the control panel of the Inverter if it displays normally
Temperature and humidity	Examine the surrounding temperature and humidity if it's under the demand of this handbook.

8.1.3 Regular Examination

Examination Item	Examination Content and disposal
Terminal blocks	Whether the screw is loose, when there is, screw it tightly by screwdriver Whether there is insulate damage, when there is, please change the terminal blocks.
Radiator	Whether there is dust stack or ventilation path is built up, when there is, please eliminate.
Electroanalysis capacitance	Whether there is color change or electroanalysis leakage, if is, please change immediately.
Print circuit board	Whether there is dust or other dirty things, when there is, please clear off.
Cool fan	Whether there is unusual voice or quiver or dust stack, when there is, please change or clear up.

8.1.4 Measure of Inverter

Because there is high-order harmonic wave in the input& output voltage and current, the choice of wrong measure instrument will induce big measure inaccuracy. Suggest measure by the instrument as follows:

Item		Simple measure	Accurate measure
Input	Voltage	Multiple meter	Moving-iron voltage meter
	Current	Forcipate meter	Moving-iron current meter
	Power		Electrodynamic power meter
Output	Voltage	Multiple meter	Moving-iron voltage meter
	Current	Forcipate meter	Moving-iron current meter
	Power		Electrodynamic power meter

8.1.5 replace of components

Different Inverter components have different operating life, meanwhile, the operating environment also change their operating life, in order to let the Inverter work normally and chronically, should replace some of the components according to the conditions. Suggest the approximate change time as the table below:

Name of components	Replace time
Cool fan	2-3 years
Electroanalysis capacitance	4-5years
Print circuit board	5-8years
Other device	According to the examination conditions

8.2 Transportation and Deposit

8.2.1 transportation of Inverter

put the Inverter upward when transport it, acutely quiver, impulse or heavy press is not allowed, and also should avoid rain and snow.

8.2.2 storage of Inverter

If the transport need temperate keeping or long-term storage, but not be used immediately, should pay attention to the following points:

The storage temperate should be within the bound of 20 to +60, and also the ground should be not humid, no dust, no metal power and ventilated.

- if the Inverter not be used more than one year, should process charge test to revive the characteristic of the main circuit filter capacitance in the Inverter.
- when charging the Inverter, rise the vol tage slowly till up to the rated input voltage, the charge time should be within 1 to 2hours.

Article9

Outline dimension and installation dimension

9.1 Outline dimension and installation dimension 70

This chapter will supply you the outline dimension and installation dimension of Inverter, and also the weight of Inverter, to let the user install conveniently.

9.1 Outline dimension and installation dimension

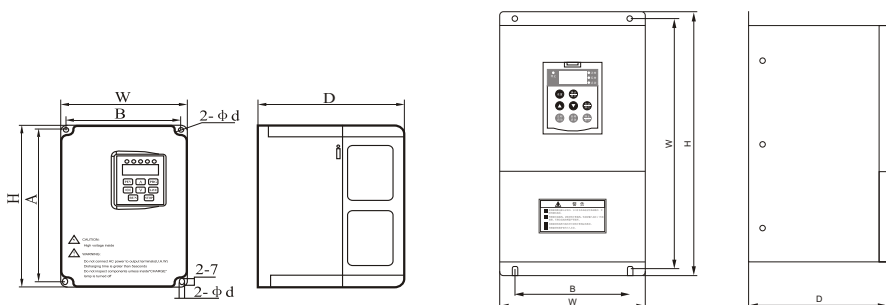

Type	Power (KW)	Dimension (mm)						G.W (Kg)
		H	W	A	B	D	d	
ZVFG7-2007T/S	0.75	170	125	159	113	142	φ 5	2
ZVFG7-4015T/S	1.5							2
ZVFG7-2022S	2.2							2
ZVFG7-4007T	0.75							2
ZVFG7-4015T	1.5							2
ZVFG7-4022T	2.2							2

Type		Power (KW)	Dimension (mm)						G.W (Kg)
ZVFG7	ZVFP7		H	W	A	B	D	d	
2022T		2.2	250	155	238	142	150	φ 5	5
2037T/S		3.7							5
4037T		3.7							5
4055T		5.5							5
2055T		5.5	300	180	280	130	168	φ 7	8
4075T		7.5							8
4110T	4110T	11	380	210	360	160	205	φ 10	11
4150T	4150T	15							11
	4185T	18.5							11

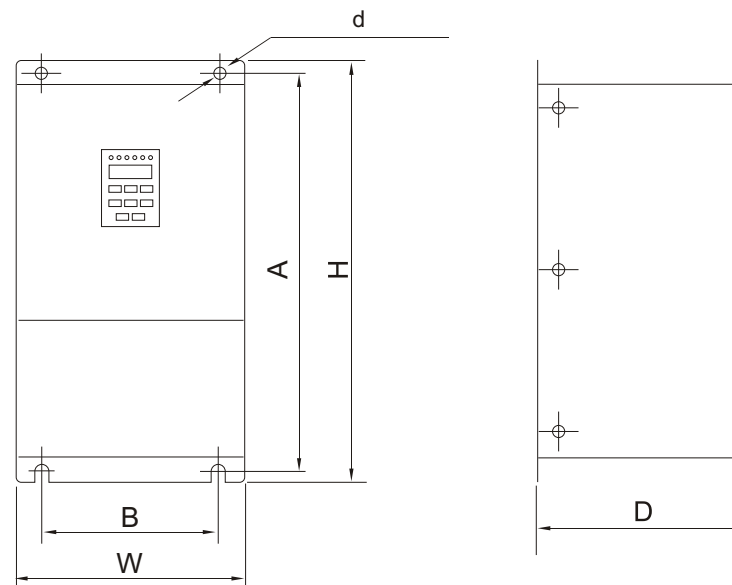

Type		Power (KW)	Dimension (mm)						G.W (Kg)
ZVFG7	ZVFP7		H	W	A	B	D	d	
4185T		18.5	470	270	450	200	230	φ 10	19
4220T	4220T	22							19
4300T	4300T	30							19.5
	4370T	37							19.5
4370T		37	630	350	600	270	290	φ 12	58
4450T	4450T	45							58
4550T	4550T	55							58.5
	4750T	75							58.5
4750T		75	760	470	725	380	310	φ 12	75
4930T	4930T	93							75
41100T	41100T	110							76
	41320T	132							76

Article10

Quality Guarantee

10.1 Quality Guarantee

73

This chapter will introduce you related content and terms if quality guarantee, hope user read it earnestly, if quality problem occurred, our company will deal with it according to this chapter instruction

10.1 Quality Guarantee

The quality guarantee of this product is according to the following standard:

1. Specific content of quality guarantee

- use this product within one month, we guarantee return, replacement and repair.
- use this product within three month s, we guarantee replacement and repair.
- use this product within twelve month s, we guarantee repair.

2. No matter whenever, wherever use this Inverter, the user even enjoy the all-life paid service.

3. If the malfunction induced by the following reason, even if in the repair guarantee time, the repair is paid:

- Wrong operation(according to this using handbook)or problem induced by repair and rebuild personally without permission.
- Problem induced by using beyond the standard requirement.
- Damage induced by move or storage after purchasing.
- Aging or malfunction induced by bad environment
- Damage induced by earthquake, fire hazard, flood, lightning stroke, voltage exception or other nature disaster.
- The name-plate, remark, production series number couldn't be recognized.
- Not pay off the payment according to the purchase agreement.
- Couldn't describe the using condition of installation, wiring, operating and maintenance objectively.
- For the service of guarantee return, replacement and repair, should send the product back to our company, only after checking to know the responsibility worship could return or repair.

4. If the product occurs quality problem or accident, our company only take the responsibility of quality guarantee content what said in this chapter. If the user need more responsibility guarantee, please insure to insurance company personally.

Appendix

Appendix A External-connected control panel leading-out unit

External-connected control panel leading-out unit is a beside-chose component, when the user purchasing, they should mark the product with this unit. The external-connected control panel leading-out unit includes a panel, a installation base of operating panel and a leading-out wire.

Installation step of Inverter and out-connected control panel show follow:

1. Take the operating panel out (press downward the arrow directs emphatically by hand, then pull out the operating panel)
2. Install the leading-out panel on the Inverter
3. Put the pulled-out operating panel in the installation base, then install the base of the operating panel wherever need.
4. Then connect the pulled-out panel with operating panel with leading-out wire.

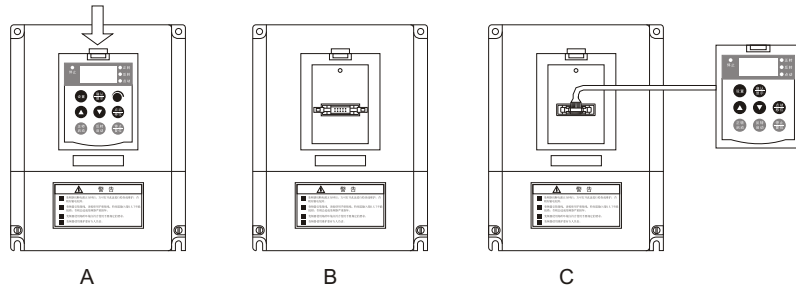

Dimension of open pore of installation base for operating panel:

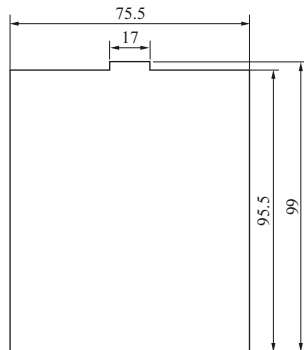

Appendix B Brake unit and braking resistance

Inverter		Brake unit		Braking resistance		
Voltage	Max. capacity (KW)	Item	Qty	Recommend resistance value	Specification of resistance	Qty
200V	0.75	Pre-set		160W150 Ω	160W150 Ω	1
	1.5	Pre-set		400W80 Ω	400W80 Ω	1
	2.2	Inner-set		600W45 Ω	600W45 Ω	1
400V	1.5	Inner-set		180W300 Ω	180W300 Ω	1
	2.2	Inner-set		250W250 Ω	250W250 Ω	1
	3.7	Inner-set		400W150 Ω	400W150 Ω	1
	5.5	Inner-set		600W100 Ω	600W100 Ω	1
	7.5	Inner-set	1	800W75 Ω	800W75 Ω	1
	11	Inner-set	1	1000W50 Ω	1000W50 Ω	1
	15	Inner-set	1	1500W40 Ω	1500W40 Ω	1
	18.5	4030	1	2500W35 Ω	2500W35 Ω	1
	22	4030	1	3000W27.2 Ω	1200W6.8 Ω	4
	30	4030	1	5000W17.5 Ω	2500W35 Ω	2
	37	4045	1	9600W16 Ω	1200W8 Ω	8
	45	4045	1	9600W13.6 Ω	1200W6.8 Ω	8
	55	4030	2	6000W20 Ω	1500W5 Ω	8
	75	4045	2	9600W15 Ω	1200W7.5 Ω	16
	93	4045	2	9600W13.6 Ω	1200W6.8 Ω	16

Matters need attention:

1. Power of brake resistance and resistance value recommended in the table above are both calculated by 100% braking torque and 10% use-frequency, if user need increase the braking torque or the use-frequency is high, they should change the braking torque and the resistance value or inquire our company.
2. Please consider the security of surrounding environment when install the braking resistance.

Appendix C Using instruction of ambitus device for Inverter

Installation instruction:

■ **DC reactor**
 In order to improve the power factor of Inverter, user could choose to install DC reactor

■ **Brake unit and braking resistance**
 If the Inverter used for big-inertia and short-braking time device, user should choose to install brake unit and braking resistance (15KW and below has installed inner brake unit).Data of braking resistance seen to Appendix B.

■ **Output-side filter**
 Could choose to install loading filter to reduce radiation interference and induction noise or decrease motor noise and waste.

■ **Thermal relay**
 When use one Inverter to drive more motors, should increase installing thermal relay. Please don't install thermal relay when one Inverter drive one motor (the specification of the thermal relay should match the rated current of motor).

■ **Motor**
 When use one Inverter to drive more motors, the capacity of the Inverter should bigger than total capacity of simultaneous-operating motors.

installation instruction

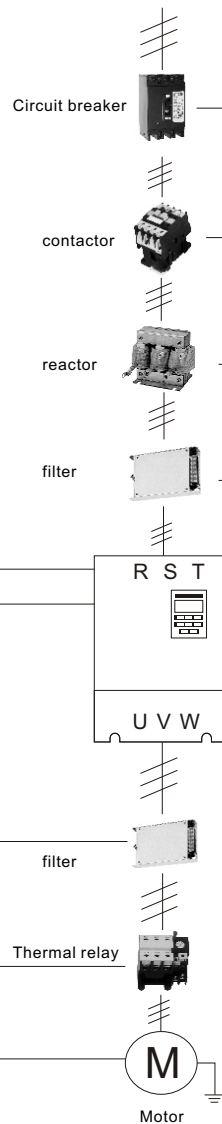

■ **Circuit breaker**
 Between the input power and the main circuit terminals should install a no-fuse circuit breaker as the power switch for the Inverter, then the Inverter could be repaired and maintained conveniently. Please don't use it as the daily on-and-off switch for the Inverter.

■ **Magnetic contactor**
 It's unnecessary to install magnetic contactor for general-use, but recommend it's better to install a magnetic contactor to cut off power when the Inverter's protection operated. Should install magnetic contactor if need out-side increase-and-decrease speed set or restart when power off. But don't use it as the daily on-and-off switch for the Inverter.

■ **Input-side AC reactor**
 Should install AC reactor under the following condition:

- The capacity of power transformer is above 500KVA, and the capacity of power transformer is more than decuple capacity for Inverter.
- The unbalance between the three phase output-voltage of the power transformer.
- The crystal brake tube is on-load at the same power.
- There is electric capacitor at the side of power which regulate power factor by controlling on/off.

■ **Input-side filter**
 When the Inverter working, it will bring harmonic, which will interfere the surrounding electronic sensitive device, so please choose to install input-side filter if there is electronic sensitive device surround the Inverter (suitable for below 22KW).